



**IP Office**

**IP Office J100 Series Phone User Guide**

Release 11.1 FP1  
Issue 4  
March 2021

© 2021, Avaya Inc.  
All Rights Reserved.

## Notice

While reasonable efforts have been made to ensure that the information in this document is complete and accurate at the time of printing, Avaya assumes no liability for any errors. Avaya reserves the right to make changes and corrections to the information in this document without the obligation to notify any person or organization of such changes.

## Documentation disclaimer

"Documentation" means information published in varying mediums which may include product information, operating instructions and performance specifications that are generally made available to users of products. Documentation does not include marketing materials. Avaya shall not be responsible for any modifications, additions, or deletions to the original published version of Documentation unless such modifications, additions, or deletions were performed by or on the express behalf of Avaya. End User agrees to indemnify and hold harmless Avaya, Avaya's agents, servants and employees against all claims, lawsuits, demands and judgments arising out of, or in connection with, subsequent modifications, additions or deletions to this documentation, to the extent made by End User.

## Link disclaimer

Avaya is not responsible for the contents or reliability of any linked websites referenced within this site or Documentation provided by Avaya. Avaya is not responsible for the accuracy of any information, statement or content provided on these sites and does not necessarily endorse the products, services, or information described or offered within them. Avaya does not guarantee that these links will work all the time and has no control over the availability of the linked pages.

## Warranty

Avaya provides a limited warranty on Avaya hardware and software. Refer to your sales agreement to establish the terms of the limited warranty. In addition, Avaya's standard warranty language, as well as information regarding support for this product while under warranty is available to Avaya customers and other parties through the Avaya Support website: <https://support.avaya.com/helpcenter/getGenericDetails?detailId=C20091120112456651010> under the link "Warranty & Product Lifecycle" or such successor site as designated by Avaya. Please note that if You acquired the product(s) from an authorized Avaya Channel Partner outside of the United States and Canada, the warranty is provided to You by said Avaya Channel Partner and not by Avaya.

"Hosted Service" means an Avaya hosted service subscription that You acquire from either Avaya or an authorized Avaya Channel Partner (as applicable) and which is described further in Hosted SAS or other service description documentation regarding the applicable hosted service. If You purchase a Hosted Service subscription, the foregoing limited warranty may not apply but You may be entitled to support services in connection with the Hosted Service as described further in your service description documents for the applicable Hosted Service. Contact Avaya or Avaya Channel Partner (as applicable) for more information.

## Hosted Service

THE FOLLOWING APPLIES ONLY IF YOU PURCHASE AN AVAYA HOSTED SERVICE SUBSCRIPTION FROM AVAYA OR AN AVAYA CHANNEL PARTNER (AS APPLICABLE), THE TERMS OF USE FOR HOSTED SERVICES ARE AVAILABLE ON THE AVAYA WEBSITE, [HTTPS://SUPPORT.AVAYA.COM/LICENSEINFO](https://support.avaya.com/licenseinfo) UNDER THE LINK "Avaya Terms of Use for Hosted Services" OR SUCH SUCCESSOR SITE AS DESIGNATED BY AVAYA, AND ARE APPLICABLE TO ANYONE WHO ACCESSES OR USES THE HOSTED SERVICE. BY ACCESSING OR USING THE HOSTED SERVICE, OR AUTHORIZING OTHERS TO DO SO, YOU, ON BEHALF OF YOURSELF AND THE ENTITY FOR WHOM YOU ARE DOING SO (HEREINAFTER REFERRED TO INTERCHANGEABLY AS "YOU" AND "END USER"), AGREE TO THE TERMS OF USE. IF YOU ARE ACCEPTING THE TERMS OF USE ON BEHALF A COMPANY OR OTHER LEGAL ENTITY, YOU REPRESENT THAT YOU HAVE THE AUTHORITY TO BIND SUCH ENTITY TO THESE TERMS OF USE. IF YOU DO NOT HAVE SUCH AUTHORITY, OR IF

YOU DO NOT WISH TO ACCEPT THESE TERMS OF USE, YOU MUST NOT ACCESS OR USE THE HOSTED SERVICE OR AUTHORIZE ANYONE TO ACCESS OR USE THE HOSTED SERVICE.

## Licenses

THE SOFTWARE LICENSE TERMS AVAILABLE ON THE AVAYA WEBSITE, [HTTPS://SUPPORT.AVAYA.COM/LICENSEINFO](https://support.avaya.com/licenseinfo), UNDER THE LINK "AVAYA SOFTWARE LICENSE TERMS (Avaya Products)" OR SUCH SUCCESSOR SITE AS DESIGNATED BY AVAYA, ARE APPLICABLE TO ANYONE WHO DOWNLOADS, USES AND/OR INSTALLS AVAYA SOFTWARE, PURCHASED FROM AVAYA INC., ANY AVAYA AFFILIATE, OR AN AVAYA CHANNEL PARTNER (AS APPLICABLE) UNDER A COMMERCIAL AGREEMENT WITH AVAYA OR AN AVAYA CHANNEL PARTNER. UNLESS OTHERWISE AGREED TO BY AVAYA IN WRITING, AVAYA DOES NOT EXTEND THIS LICENSE IF THE SOFTWARE WAS OBTAINED FROM ANYONE OTHER THAN AVAYA, AN AVAYA AFFILIATE OR AN AVAYA CHANNEL PARTNER; AVAYA RESERVES THE RIGHT TO TAKE LEGAL ACTION AGAINST YOU AND ANYONE ELSE USING OR SELLING THE SOFTWARE WITHOUT A LICENSE. BY INSTALLING, DOWNLOADING OR USING THE SOFTWARE, OR AUTHORIZING OTHERS TO DO SO, YOU, ON BEHALF OF YOURSELF AND THE ENTITY FOR WHOM YOU ARE INSTALLING, DOWNLOADING OR USING THE SOFTWARE (HEREINAFTER REFERRED TO INTERCHANGEABLY AS "YOU" AND "END USER"), AGREE TO THESE TERMS AND CONDITIONS AND CREATE A BINDING CONTRACT BETWEEN YOU AND AVAYA INC. OR THE APPLICABLE AVAYA AFFILIATE ("AVAYA").

Avaya grants You a license within the scope of the license types described below, with the exception of Heritage Nortel Software, for which the scope of the license is detailed below. Where the order documentation does not expressly identify a license type, the applicable license will be a Designated System License as set forth below in the Designated System(s) License (DS) section as applicable. The applicable number of licenses and units of capacity for which the license is granted will be one (1), unless a different number of licenses or units of capacity is specified in the documentation or other materials available to You. "Software" means computer programs in object code, provided by Avaya or an Avaya Channel Partner, whether as stand-alone products, pre-installed on hardware products, and any upgrades, updates, patches, bug fixes, or modified versions thereto. "Designated Processor" means a single stand-alone computing device. "Server" means a set of Designated Processors that hosts (physically or virtually) a software application to be accessed by multiple users. "Instance" means a single copy of the Software executing at a particular time: (i) on one physical machine; or (ii) on one deployed software virtual machine ("VM") or similar deployment.

## License type(s)

Designated System(s) License (DS). End User may install and use each copy or an Instance of the Software only: 1) on a number of Designated Processors up to the number indicated in the order; or 2) up to the number of Instances of the Software as indicated in the order, Documentation, or as authorized by Avaya in writing. Avaya may require the Designated Processor(s) to be identified in the order by type, serial number, feature key, Instance, location or other specific designation, or to be provided by End User to Avaya through electronic means established by Avaya specifically for this purpose.

Concurrent User License (CU). End User may install and use the Software on multiple Designated Processors or one or more Servers, so long as only the licensed number of Units are accessing and using the Software at any given time as indicated in the order, Documentation, or as authorized by Avaya in writing. A "Unit" means the unit on which Avaya, at its sole discretion, bases the pricing of its licenses and can be, without limitation, an agent, port or user, an e-mail or voice mail account in the name of a person or corporate function (e.g., webmaster or helpdesk), or a directory entry in the administrative database utilized by the Software that permits one user to interface with the Software. Units may be linked to a specific, identified Server or an Instance of the Software.

Cluster License (CL). End User may install and use each copy or an Instance of the Software only up to the number of Clusters as indicated on the order, Documentation, or as authorized by Avaya in writing with a default of one (1) Cluster if not stated.

Enterprise License (EN). End User may install and use each copy or an Instance of the Software only for enterprise-wide use of an unlimited number of Instances of the Software as indicated on the order, Documentation, or as authorized by Avaya in writing.

Named User License (NU). End User may: (i) install and use each copy or Instance of the Software on a single Designated Processor or Server per authorized Named User (defined below); or (ii) install and use each copy or Instance of the Software on a Server so long as only authorized Named Users access and use the Software as indicated in the order, Documentation, or as authorized by Avaya in writing. "Named User", means a user or device that has been expressly authorized by Avaya to access and use the Software. At Avaya's sole discretion, a "Named User" may be, without limitation, designated by name, corporate function (e.g., webmaster or helpdesk), an e-mail or voice mail account in the name of a person or corporate function, or a directory entry in the administrative database utilized by the Software that permits one user to interface with the Software.

Shrinkwrap License (SR). End User may install and use the Software in accordance with the terms and conditions of the applicable license agreements, such as "shrinkwrap" or "clickthrough" license accompanying or applicable to the Software ("Shrinkwrap License") as indicated in the order, Documentation, or as authorized by Avaya in writing.

Transaction License (TR). End User may use the Software up to the number of Transactions as specified during a specified time period and as indicated in the order, Documentation, or as authorized by Avaya in writing. A "Transaction" means the unit by which Avaya, at its sole discretion, bases the pricing of its licensing and can be, without limitation, measured by the usage, access, interaction (between client/server or customer/organization), or operation of the Software within a specified time period (e.g. per hour, per day, per month). Some examples of Transactions include but are not limited to each greeting played/message waiting enabled, each personalized promotion (in any channel), each callback operation, each live agent or web chat session, each call routed or redirected (in any channel). End User may not exceed the number of Transactions without Avaya's prior consent and payment of an additional fee.

#### **Heritage Nortel Software**

"Heritage Nortel Software" means the software that was acquired by Avaya as part of its purchase of the Nortel Enterprise Solutions Business in December 2009. The Heritage Nortel Software is the software contained within the list of Heritage Nortel Products located at <https://support.avaya.com/LicenseInfo> under the link "Heritage Nortel Products" or such successor site as designated by Avaya. For Heritage Nortel Software, Avaya grants Customer a license to use Heritage Nortel Software provided hereunder solely to the extent of the authorized activation or authorized usage level, solely for the purpose specified in the Documentation, and solely as embedded in, for execution on, or for communication with Avaya equipment. Charges for Heritage Nortel Software may be based on extent of activation or use authorized as specified in an order or invoice.

#### **Copyright**

Except where expressly stated otherwise, no use should be made of materials on this site, the Documentation, Software, Hosted Service, or hardware provided by Avaya. All content on this site, the documentation, Hosted Service, and the product provided by Avaya including the selection, arrangement and design of the content is owned either by Avaya or its licensors and is protected by copyright and other intellectual property laws including the sui generis rights relating to the protection of databases. You may not modify, copy, reproduce, republish, upload, post, transmit or distribute in any way any content, in whole or in part, including any code and software unless expressly authorized by Avaya. Unauthorized reproduction, transmission, dissemination, storage, and or use without the express written consent of Avaya can be a criminal, as well as a civil offense under the applicable law.

#### **Virtualization**

The following applies if the product is deployed on a virtual machine. Each product has its own ordering code and license types. Unless otherwise stated, each Instance of a product must be separately licensed and ordered. For example, if the end user customer or Avaya Channel Partner would like to install two Instances of the

same type of products, then two products of that type must be ordered.

#### **Third Party Components**

"Third Party Components" mean certain software programs or portions thereof included in the Software or Hosted Service may contain software (including open source software) distributed under third party agreements ("Third Party Components"), which contain terms regarding the rights to use certain portions of the Software ("Third Party Terms"). As required, information regarding distributed Linux OS source code (for those products that have distributed Linux OS source code) and identifying the copyright holders of the Third Party Components and the Third Party Terms that apply is available in the products, Documentation or on Avaya's website at: <https://support.avaya.com/Copyright> or such successor site as designated by Avaya. The open source software license terms provided as Third Party Terms are consistent with the license rights granted in these Software License Terms, and may contain additional rights benefiting You, such as modification and distribution of the open source software. The Third Party Terms shall take precedence over these Software License Terms, solely with respect to the applicable Third Party Components to the extent that these Software License Terms impose greater restrictions on You than the applicable Third Party Terms.

The following applies only if the H.264 (AVC) codec is distributed with the product. THIS PRODUCT IS LICENSED UNDER THE AVC PATENT PORTFOLIO LICENSE FOR THE PERSONAL USE OF A CONSUMER OR OTHER USES IN WHICH IT DOES NOT RECEIVE REMUNERATION TO (i) ENCODE VIDEO IN COMPLIANCE WITH THE AVC STANDARD ("AVC VIDEO") AND/OR (ii) DECODE AVC VIDEO THAT WAS ENCODED BY A CONSUMER ENGAGED IN A PERSONAL ACTIVITY AND/OR WAS OBTAINED FROM A VIDEO PROVIDER LICENSED TO PROVIDE AVC VIDEO. NO LICENSE IS GRANTED OR SHALL BE IMPLIED FOR ANY OTHER USE. ADDITIONAL INFORMATION MAY BE OBTAINED FROM MPEG LA, L.L.C. SEE [HTTP://WWW.MPEGLA.COM](http://www.mpegla.com).

#### **Service Provider**

THE FOLLOWING APPLIES TO AVAYA CHANNEL PARTNER'S HOSTING OF AVAYA PRODUCTS OR SERVICES. THE PRODUCT OR HOSTED SERVICE MAY USE THIRD PARTY COMPONENTS SUBJECT TO THIRD PARTY TERMS AND REQUIRE A SERVICE PROVIDER TO BE INDEPENDENTLY LICENSED DIRECTLY FROM THE THIRD PARTY SUPPLIER. AN AVAYA CHANNEL PARTNER'S HOSTING OF AVAYA PRODUCTS MUST BE AUTHORIZED IN WRITING BY AVAYA AND IF THOSE HOSTED PRODUCTS USE OR EMBED CERTAIN THIRD PARTY SOFTWARE, INCLUDING BUT NOT LIMITED TO MICROSOFT SOFTWARE OR CODECS, THE AVAYA CHANNEL PARTNER IS REQUIRED TO INDEPENDENTLY OBTAIN ANY APPLICABLE LICENSE AGREEMENTS, AT THE AVAYA CHANNEL PARTNER'S EXPENSE, DIRECTLY FROM THE APPLICABLE THIRD PARTY SUPPLIER.

WITH RESPECT TO CODECS, IF THE AVAYA CHANNEL PARTNER IS HOSTING ANY PRODUCTS THAT USE OR EMBED THE H.264 CODEC OR H.265 CODEC, THE AVAYA CHANNEL PARTNER ACKNOWLEDGES AND AGREES THE AVAYA CHANNEL PARTNER IS RESPONSIBLE FOR ANY AND ALL RELATED FEES AND/OR ROYALTIES. THE H.264 (AVC) CODEC IS LICENSED UNDER THE AVC PATENT PORTFOLIO LICENSE FOR THE PERSONAL USE OF A CONSUMER OR OTHER USES IN WHICH IT DOES NOT RECEIVE REMUNERATION TO: (I) ENCODE VIDEO IN COMPLIANCE WITH THE AVC STANDARD ("AVC VIDEO") AND/OR (II) DECODE AVC VIDEO THAT WAS ENCODED BY A CONSUMER ENGAGED IN A PERSONAL ACTIVITY AND/OR WAS OBTAINED FROM A VIDEO PROVIDER LICENSED TO PROVIDE AVC VIDEO. NO LICENSE IS GRANTED OR SHALL BE IMPLIED FOR ANY OTHER USE. ADDITIONAL INFORMATION FOR H.264 (AVC) AND H.265 (HEVC) CODECS MAY BE OBTAINED FROM MPEG LA, L.L.C. SEE [HTTP://WWW.MPEGLA.COM](http://www.mpegla.com).

#### **Compliance with Laws**

You acknowledge and agree that it is Your responsibility for complying with any applicable laws and regulations, including, but not limited to laws and regulations related to call recording, data privacy, intellectual property, trade secret, fraud, and music performance rights, in the country or territory where the Avaya product is used.

## **Preventing Toll Fraud**

“Toll Fraud” is the unauthorized use of your telecommunications system by an unauthorized party (for example, a person who is not a corporate employee, agent, subcontractor, or is not working on your company's behalf). Be aware that there can be a risk of Toll Fraud associated with your system and that, if Toll Fraud occurs, it can result in substantial additional charges for your telecommunications services.

### **Avaya Toll Fraud intervention**

If You suspect that You are being victimized by Toll Fraud and You need technical assistance or support, call Technical Service Center Toll Fraud Intervention Hotline at +1-800-643-2353 for the United States and Canada. For additional support telephone numbers, see the Avaya Support website: <https://support.avaya.com> or such successor site as designated by Avaya.

### **Security Vulnerabilities**

Information about Avaya's security support policies can be found in the Security Policies and Support section of <https://support.avaya.com/security>.

Suspected Avaya product security vulnerabilities are handled per the Avaya Product Security Support Flow (<https://support.avaya.com/css/P8/documents/100161515>).

### **Downloading Documentation**

For the most current versions of Documentation, see the Avaya Support website: <https://support.avaya.com>, or such successor site as designated by Avaya.

### **Contact Avaya Support**

See the Avaya Support website: <https://support.avaya.com> for product or Hosted Service notices and articles, or to report a problem with your Avaya product or Hosted Service. For a list of support telephone numbers and contact addresses, go to the Avaya Support website: <https://support.avaya.com> (or such successor site as designated by Avaya), scroll to the bottom of the page, and select Contact Avaya Support.

### **Trademarks**

The trademarks, logos and service marks (“Marks”) displayed in this site, the Documentation, Hosted Service(s), and product(s) provided by Avaya are the registered or unregistered Marks of Avaya, its affiliates, its licensors, its suppliers, or other third parties. Users are not permitted to use such Marks without prior written consent from Avaya or such third party which may own the Mark. Nothing contained in this site, the Documentation, Hosted Service(s) and product(s) should be construed as granting, by implication, estoppel, or otherwise, any license or right in and to the Marks without the express written permission of Avaya or the applicable third party.

Avaya is a registered trademark of Avaya Inc.

All non-Avaya trademarks are the property of their respective owners. Linux® is the registered trademark of Linus Torvalds in the U.S. and other countries.

# Contents

<b>Part 1: Your Phone</b> .....	12
<b>Chapter 1: Phone Overview</b> .....	13
Important Safety Information.....	14
Other User Guides.....	14
J129 Telephone.....	15
J139 Telephone.....	16
J159 Telephone.....	17
J169 Telephone.....	19
J179 Telephone.....	21
J189 Telephone.....	22
Button Modules.....	24
The Phone Stand.....	25
<b>Chapter 2: Phone Keys and Display</b> .....	26
Phone Keys.....	26
Call Soft Keys.....	28
Programmable Feature Buttons.....	29
Icons.....	30
<b>Chapter 3: Status Display</b> .....	32
Status Icons.....	32
Status Letters.....	33
<b>Chapter 4: Appearance Buttons</b> .....	35
Call Appearance Buttons.....	36
Bridged Appearance Buttons.....	37
Call Coverage Buttons.....	37
Line Appearance Buttons.....	37
<b>Part 2: Making and Answering Calls</b> .....	39
<b>Chapter 5: Making Calls</b> .....	40
Making a Call.....	40
Making Additional Calls.....	41
Calling from Your Contacts.....	41
Calling from the Call Log.....	42
Redialling a Previous Number.....	43
Redialling in List Mode.....	43
Redialling in Last Number Mode.....	43
Making a Page Call.....	44
Busy Indication.....	44
En-Bloc Dialing.....	45
Dialing a Number in En-Bloc Mode.....	45

Enabling/Disabling En-Bloc Dialing.....	45
Withholding Your Number.....	46
Adjusting the Call Volume.....	46
Muting a Call.....	47
Ending Calls.....	47
<b>Chapter 6: Answering Calls.....</b>	<b>48</b>
Answering a New Call.....	48
Answering Another Call.....	49
Diverting a Call to Voicemail.....	50
Silence (Ignore) an Alerting Call.....	50
Dropping an Incoming Call.....	50
Page Calls.....	51
Displaying Other Calls.....	51
Using Call Pickup.....	52
Call Pickup Short Codes.....	53
<b>Chapter 7: Redialling.....</b>	<b>54</b>
Redialling in List Mode.....	54
Redialling a Previous Number.....	55
Selecting Your Redial Mode.....	55
<b>Chapter 8: Transferring Calls.....</b>	<b>56</b>
Transferring a Call to Voicemail.....	57
Transferring a Held Call.....	57
Transferring a Call to Your Mobile.....	58
<b>Chapter 9: Holding Calls.....</b>	<b>59</b>
Holding Conference Calls.....	59
Holding a Call.....	60
Taking a Call Off Hold.....	60
Switching Between Calls.....	61
Transferring a Held Call.....	61
<b>Chapter 10: Parking Calls.....</b>	<b>63</b>
Parking Short Codes.....	63
Parking Calls ( <i>Features Menu</i> ).....	64
Unparking Calls Using the Status Menu.....	64
Park & Page.....	65
<b>Chapter 11: Conferencing.....</b>	<b>67</b>
Starting a Conference.....	67
Turning a Normal Call Into a Conference.....	68
Adding Another Party Using Hold.....	68
Adding Another Party Without Using Hold.....	69
Viewing Conference Details.....	69
Dropping/Muting Parties.....	70
Holding a Conference Call.....	70

Exiting a Conference.....	70
Context Sensitive Conferencing.....	71
Conference Short Codes.....	72
<b>Part 3: Redirecting Your Calls.....</b>	<b>74</b>
Call Redirection Options.....	74
<b>Chapter 12: Forwarding Calls.....</b>	<b>76</b>
Forward Unconditional ( <i>Status Menu</i> ).....	77
Forward Unconditional ( <i>Features Menu</i> ).....	78
Forward on Busy/No Answer ( <i>Features Menu</i> ).....	78
Forward on No Answer ( <i>Status Menu</i> ).....	79
Forward on Busy ( <i>Status Menu</i> ).....	80
Call Forwarding Short Codes.....	80
<b>Chapter 13: Do Not Disturb.....</b>	<b>82</b>
DND On/Off ( <i>Features Menu</i> ).....	82
DND Off ( <i>Status Menu</i> ).....	83
Do Not Disturb Exceptions.....	83
Do Not Disturb Short Codes.....	84
<b>Chapter 14: Follow Me.....</b>	<b>85</b>
Follow Me To ( <i>Features Menu</i> ).....	85
Follow Me ( <i>Status Menu</i> ).....	86
Follow Me Here ( <i>Features Menu</i> ).....	86
Follow Me Here ( <i>Status Menu</i> ).....	87
Follow Me Short Codes.....	87
<b>Chapter 15: Twinning.....</b>	<b>89</b>
Switching Mobile Twinning On.....	90
Changing Your Twinning Number.....	90
Transferring a Call to Your Mobile.....	91
Reclaiming a Twinned Call.....	91
Switching Mobile Twinning Off.....	91
Switching Fallback Twinning On.....	92
Switching Fallback Twinning Off.....	92
<b>Part 4: Contacts and Call Log.....</b>	<b>94</b>
<b>Chapter 16: Contacts.....</b>	<b>95</b>
How the Directory Search Works.....	96
Managing External Contacts.....	99
Viewing Contacts.....	99
Making a Call from the Directory.....	100
Using the Directory for Other Functions.....	101
Adding a New Contact.....	101
Adding a Contact from Your Call Log.....	102
Editing a Contact.....	103
Deleting a Contact.....	103

<b>Chapter 17: Using the Call Log</b> .....	105
Missed Calls.....	105
Missed Group Calls.....	106
Accessing Your Call Log.....	106
Making a Call from Your Call Log.....	107
Viewing Call Details.....	107
Deleting a Call from Your Call Log.....	108
Deleting the Whole Call Log.....	109
Adding a Call Log Call to Your Contacts.....	109
<b>Part 5: Voicemail</b> .....	111
<b>Chapter 18: Voicemail</b> .....	112
Message Waiting Indication.....	112
Accessing the Visual Voice Menus.....	113
Checking Messages Using Visual Voice.....	113
Leaving a Message.....	114
Using Voicemail Email.....	115
Recording Your Mailbox Greeting.....	115
Record Your Name.....	116
Changing Your Voicemail Code.....	117
Switching Voicemail On/Off.....	117
Transferring a Call to Voicemail.....	118
Sending an Incoming Call to Your Mailbox.....	118
Voicemail Short Codes.....	118
Other Mailbox Guides.....	119
<b>Part 6: Other Features</b> .....	120
<b>Chapter 19: Account Codes</b> .....	121
Forced Account Codes.....	121
Manual Account Code Entry.....	122
<b>Chapter 20: Headset Operation</b> .....	123
Using a Heaset.....	123
Headset Selection.....	124
Headset Caller Volume.....	124
Headset Microphone Volume.....	125
Headset Profile.....	125
Automatic Gain Control.....	126
Default Handsfree Audio Path.....	127
Using Bluetooth Headsets.....	127
Enabling Bluetooth Support.....	128
Pairing a Bluetooth Headset.....	128
Selecting a Paired Headset.....	129
Headset Alert Sounds.....	129
<b>Chapter 21: Handsfree Speaker Operation</b> .....	131



Using Handsfree.....	131
Speaker Volume.....	132
Default Audio Path.....	132
Automatic Gain Control.....	133
<b>Chapter 22: Logging In/Out.....</b>	<b>134</b>
Logging In.....	135
Logging In on Another User’s Phone.....	135
Logging In on a “Not Logged In” Phone.....	136
Logging In on an Unregistered Phone.....	136
Logging Out.....	137
Changing Your Security PIN.....	137
Locking Your Phone.....	138
Unlocking Your Phone.....	138
Auto Lock.....	139
Login Short Codes.....	140
<b>Chapter 23: Groups.....</b>	<b>141</b>
Group Membership.....	141
Switching Your Group Membership On/Off (Status Menu).....	142
Switching Your Group Membership On/Off ( <i>Features Menu</i> ).....	142
Group Service Status and Fallback.....	143
Changing a Group’s Service Status ( <i>Features Menu</i> ).....	144
Changing a Group’s Service Status (Status Menu).....	145
Changing a Group’s Fallback Destination.....	145
Short Codes.....	146
<b>Part 7: Phone Configuration.....</b>	<b>147</b>
<b>Chapter 24: Ringer Controls.....</b>	<b>148</b>
Disabling the Ringer.....	148
Visual Alerting.....	149
Coverage Ring.....	149
Ringer Volume.....	150
Internal Auto-Answer.....	150
<b>Chapter 25: Display Controls.....</b>	<b>151</b>
Display Brightness.....	151
Display Contrast.....	152
Single/Dual Column Display.....	152
Last Call Duration Display.....	153
Call Timer Display.....	153
Display Language.....	154
Auto Display Waiting Call.....	155
Inactivity Timer (Auto-Return).....	155
Background Image.....	156
Backlight Timer.....	156

Text Size.....	157
<b>Chapter 26: Screen Saver.....</b>	<b>158</b>
Selecting the Screen Saver.....	158
Manually Activating the Screen Saver.....	159
Setting the Screen Saver Timeout.....	159
Show the Clock on the Screen Saver.....	159
<b>Chapter 27: Volume and Sound.....</b>	<b>161</b>
Button Clicks.....	161
Error Tones.....	162
Ringer Volume.....	162
Handset Volume.....	162
Handset Profile.....	163
Headset Volume.....	163
Headset Profile.....	164
Speaker Volume.....	165
Automatic Gain Control.....	165
Default Handsfree Audio Path.....	165
<b>Chapter 28: Programmable Feature Buttons.....</b>	<b>167</b>
Editing Your Programmable Buttons.....	167
Programmable Button Features.....	168
Abbreviated Dial Button.....	169
Absence Text Button.....	169
Account Code Button.....	169
Auto Answer Button.....	169
Call Forward All Button.....	170
Call Park Button.....	170
Call Park to Other Button.....	170
Call Pickup Button.....	171
Call Pickup Any Button.....	171
Conf Meet Me Button.....	171
Drop Button.....	171
Flash Hook Button.....	172
Group Button.....	172
Page Button.....	172
Park and Page Button.....	172
Ringer Off Button.....	172
Self-Administer Button.....	173
Send All Calls Button.....	173
Suppress Digits Button.....	173
Twinning Button.....	173
User Button.....	174
<b>Part 8: Miscellaneous.....</b>	<b>175</b>

<b>Chapter 29: Short Codes</b> .....	176
<b>Chapter 30: System Administration</b> .....	179
Checking the System Information.....	179
Checking the Time Server Status.....	180
Setting the Date.....	180
Setting the Time.....	181
Setting the Time Offset.....	182
Restarting the System.....	183
Managing the Memory Cards.....	184
Reporting System Alarms.....	185
<b>Chapter 31: The Status Menu</b> .....	186
Do Not Disturb.....	186
Follow Me To.....	187
Follow Me Here.....	187
Forward on Busy.....	187
Forward on No Answer.....	188
Forward Unconditional.....	189
Forwarded Here.....	189
Group Membership.....	190
Group Status.....	190
Switch Mobile Twinning Off.....	191
Parked Calls.....	191
System Alarms.....	192
<b>Chapter 32: Menus</b> .....	193
Status Menu.....	193
Features Menu.....	194
Main Menu.....	195
Menu Access Control.....	195
J139 Restrictions.....	197
<b>Chapter 33: Entering Text Characters</b> .....	198
Entering Characters for a Directory Search.....	198
Entering Additional and Accented Characters.....	198
Entering Characters for Other Functions.....	199

# Part 1: Your Phone

# Chapter 1: Phone Overview

This guide covers using the J100 Series telephones on IP Office telephone systems (except the J129 which has its own separate documentation).

These phones are supported on a number of Avaya telephone systems and support different features depending on the telephone system. This guide covers only the features supported on an IP Office telephone system.

Phone	Programmable Buttons <sup>[1]</sup>	Color Display	Optional WiFi	Optional Bluetooth	Headset Socket	Speaker Phone	Button Module Support
J129	–	–	Yes	–	–	Yes	–
J139	12	Yes	–	–	Yes	Yes	–
J159	48	Yes	Yes	–	Yes	Yes	–
J169	24	–	–	–	Yes	Yes	JBM24 x 3
J179	24	Yes	Yes	Yes	Yes	Yes	JEM24 x 3
J189	48	Yes	Yes	Yes	Yes	Yes	JEM24 x 2

1. On phones which support button modules, the number of buttons supported can be increased by the addition of modules.

## Related links

[Important Safety Information](#) on page 14

[Other User Guides](#) on page 14

[J129 Telephone](#) on page 15

[J139 Telephone](#) on page 16

[J159 Telephone](#) on page 17

[J169 Telephone](#) on page 19

[J179 Telephone](#) on page 21

[J189 Telephone](#) on page 22

[Button Modules](#) on page 24

[The Phone Stand](#) on page 25

---

## Important Safety Information

### Warning:

- This handset may pick up small metal objects such as metal pins or staples.
- During a power surge, EFT (Electronically Fast Transients), or ESD (Electrostatic Discharge), calls may be dropped. After a power surge, EFT or ESD, it is normal for the phone to restart.
- Using a cell phone, mobile phone, GSM phone or two-way radio in close proximity to an Avaya telephone might cause interference.
- The phone should not be connected directly to the outdoor telecommunication network.

### Related links

[Phone Overview](#) on page 13

---

## Other User Guides

The IP Office system supports a wide range of phones. If you suspect that this is not the correct user guide for your phone, one of the following links may assist. We have also provided links for voicemail guides and other user applications:

### Telephone User Guides

- [IP Office Analog Phone User Guide](#)
- [IP Office 9500 Series Quick Reference](#)
- [IP Office 9500 Series Phone User Guide](#)
- [IP Office 9600 Series Quick Reference](#)
- [IP Office 9600 Series Phone User Guide](#)
- [IP Office J100 Series Quick Reference](#)
- [IP Office J100 Series Phone User Guide](#)

### Application User Guides

- [Using IP Office Self-Administration](#)
- [Using Avaya Workplace Client for IP Office](#)
- [Using Avaya IP Office™ Platform Web Client](#)
- [Using IP Office Web Collaboration](#)
- [Using one-X Portal for IP Office](#)

### Mailbox User Guides

- [Using IP Office Embedded Voicemail IP Office Mode](#)

- [Using IP Office Embedded Voicemail Intuity Mode](#)
- [Using a Voicemail Pro Intuity Mode Mailbox](#)
- [Using a Voicemail Pro IP Office Mode Mailbox](#)

#### Related links

[Phone Overview](#) on page 13

---

## J129 Telephone

The J129 is the basic desk phone in the J100 series. The operation of the J129 telephone is not covered in this manual. Instead, refer to the *Using Avaya J129 IP Phone* user guide.



- 2.3" Grayscale display (128 x 32).
- No programmable buttons.
- 3 buttons under the display used for context sensitive soft key functions as indicated by the display labels above them.
- Call alerting, message waiting indication lamp.
- Dual 10/100 Mbps Ethernet ports. One for phone network connection. One for PC pass-through to allow co-location with a user PC.
- The phone includes a two-position desk stand. An optional wall mounting stand is available.
- The J129 has a slot for an optional J100 wireless module. The module allows the phone to connect to the network using Wi-Fi.

## Limitations

- The phone only displays the user's personal directory. It does not list system directory contacts.
- Various menu functions are not supported, though they can be accessed through other methods such as short code dialing. These are **Auto Callback**, **Call Fwd**, **Call Forward-Busy**, **Call Forward-No Answer**, **Call Park**, **Private Call** and **Speed Dial**.
- No support for secure call indication or presence indication.
- No support for emergency dialing when the phone is not registered with the system.

## Related links

[Phone Overview](#) on page 13

---

# J139 Telephone

The J139 telephone is a SIP telephone supported on systems with Release 11.0 Service Pack 1 or higher software.



Features include:

- 2.8" Color display (320 x 240).
- 12 programmable button slots for call appearance and feature buttons.
- The button slots can be arranged in either 3-pages of 4 (dual-column mode) or 6-pages of 2 (single column mode).



- 4 twin-LED (red and green) physical buttons are used to indicate the status of the programmable button slots currently in view on the display.
- 4 Additional buttons under the primary display. These are used for context-sensitive soft key functions. The buttons current function is indicated by the display label above it. See [Call Soft Keys](#) on page 28.
- Illuminated buttons for 🕒 missed calls/call log, 🗣️ speaker, 🎧 headset and 🤫 mute.
- Non-illuminated buttons for ✉️ messages, 👤 contacts, 📞 phone and ☰ configuration menu access.
- Call alerting/message waiting indication lamp.
- Dual 10/100/1000 Mbps Ethernet ports. One for phone network connection. One for PC pass-through to allow co-location with a user PC.
- The phone includes a two-position desk stand. An optional wall mounting stand is available.
- The J100 Series phones support the following audio codecs on IP Office: G.711, G.726a, G.729, G.729a, G.729ab, G.722.
- Power via either PoE (Power over Ethernet). The phone is a PoE Class 1 device. An optional 5V power supply unit is available for locations where PoE is not available or suitable.

### Limitations

- The phone is similar to the other J100 Series phones but only supports a sub-set of features. See [J139 Restrictions](#) on page 197.

### Related links

[Phone Overview](#) on page 13

















---





## J159 Telephone

The J159 telephone is a SIP telephone supported on systems running Release 11.1 or higher software.



Features include:

- Dual displays:
  - Primary display:
    - 2.8" Color display (320 x 240).
    - 24 programmable button slots (buttons 1 to 24). The button slots can be arranged in single or two column pages (see [Single/Dual Column Display](#) on page 152).
    - 4 twin-LED (red and green) physical buttons are used to indicate the status of the programmable button slots currently in view on the display.
  - Secondary display:
    - 2.3" Color display (160 x 240).
    - 24 programmable button slots (buttons 25 to 48). The button slots are arranged in 4-pages of 6.
    - 6 twin-LED (red and green) physical buttons are used to indicate the status of the programmable button slots currently in view on the display.
- 4 Additional buttons under the primary display. These are used for context-sensitive soft key functions. The buttons current function is indicated by the display label above it. See [Call Soft Keys](#) on page 28.
- Illuminated buttons for  missed calls/call log,  speaker,  headset and  mute.
- Non-illuminated buttons for  messages,  contacts,  phone and  configuration menu access.
- Call alerting/message waiting indication lamp.
- Dual 10/100/1000 Mbps Ethernet ports. One for phone network connection. One for PC pass-through to allow co-location with a user PC.
- The phone includes a two-position desk stand. An optional wall mounting stand is available.
- The J100 Series phones support the following audio codecs on IP Office: G.711, G.726a, G.729, G.729a, G.729ab, G.722.
- Power via either PoE (Power over Ethernet). The phone is a PoE Class 1 device. An optional 5V power supply unit is available for locations where PoE is not available or suitable.
- Slot for an optional J100 wireless module. The module allows the phone to connect to the network using Wi-Fi and/or to use Bluetooth headsets.
- 4 Additional buttons under the primary display. These are used for context-sensitive soft key functions. The buttons current function is indicated by the display label above it. See [Call Soft Keys](#) on page 28.
- Illuminated buttons for  missed calls/call log,  speaker,  headset and  mute.
- Non-illuminated buttons for  messages,  contacts,  phone and  configuration menu access.

- Additional non-illuminated buttons for  hold,  transfer,  conference and  redial operations.
- Call alerting/message waiting indication lamp.
- Dual 10/100/1000 Mbps Ethernet ports. One for phone network connection. One for PC pass-through to allow co-location with a user PC.
- The phone includes a two-position desk stand. An optional wall mounting stand is available.
- The J100 Series phones support the following audio codecs on IP Office: G.711, G.726a, G.729, G.729a, G.729ab, G.722.
- Power via either PoE (Power over Ethernet). The phone is a PoE Class 1 device. An optional 5V power supply unit is available for locations where PoE is not available or suitable.
- Slot for an optional J100 wireless module. The module allows the phone to connect to the network using Wi-Fi.
- Single USB Port supported for device charging and USB headset connection.

**Related links**

[Phone Overview](#) on page 13

---

## J169 Telephone

The J169 telephone is a SIP telephone supported on systems running Release 11.0 or higher software.



Features include:

- 3.5" Greyscale display (320 x 240).
- 24 programmable button slots (buttons 1 to 24) for call appearance and feature buttons.
  - The button slots can be arranged in single or dual column display. See [Single/Dual Column Display](#) on page 152.
  - Additional programmable buttons (buttons 25 to 96) can be added by the addition of up to 3 button modules. See [Button Modules](#) on page 24.
- 8 twin-LED (red and green) physical buttons used to indicate the status of the programmable button slots currently in view.
- 4 Additional buttons under the primary display. These are used for context-sensitive soft key functions. The buttons current function is indicated by the display label above it. See [Call Soft Keys](#) on page 28.
- Illuminated buttons for 🕒 missed calls/call log, 🔊 speaker, 🎧 headset and 🤫 mute.
- Non-illuminated buttons for ✉ messages, 👤 contacts, 📞 phone and ≡ configuration menu access.
- Call alerting/message waiting indication lamp.
- Dual 10/100/1000 Mbps Ethernet ports. One for phone network connection. One for PC pass-through to allow co-location with a user PC.

- The phone includes a two-position desk stand. An optional wall mounting stand is available.
- The J100 Series phones support the following audio codecs on IP Office: G.711, G.726a, G.729, G.729a, G.729ab, G.722.
- Power via either PoE (Power over Ethernet). The phone is a PoE Class 1 device. An optional 5V power supply unit is available for locations where PoE is not available or suitable.
  - The phone changes to PoE Class 2 when using a button module or modules.

### Related links

[Phone Overview](#) on page 13

---

## J179 Telephone

The J179 telephone is a SIP telephone supported on systems running Release 11.0 or higher software.



Features include:

- 3.5" Color display (320 x 240).
- 24 programmable button slots (buttons 1 to 24) for call appearance and feature buttons.
  - The button slots can be arranged in single or dual column display. See [Single/Dual Column Display](#) on page 152.
  - Additional programmable buttons (buttons 25 to 96) can be added by the addition of up to 3 button modules. See [Button Modules](#) on page 24.

- 8 twin-LED (red and green) physical buttons used to indicate the status of the programmable button slots currently in view.
- 4 Additional buttons under the primary display. These are used for context-sensitive soft key functions. The buttons current function is indicated by the display label above it. See [Call Soft Keys](#) on page 28.
- Illuminated buttons for 🕒 missed calls/call log, 🔊 speaker, 🎧 headset and 🤐 mute.
- Non-illuminated buttons for ✉ messages, 👤 contacts, 📞 phone and ☰ configuration menu access.
- Call alerting/message waiting indication lamp.
- Dual 10/100/1000 Mbps Ethernet ports. One for phone network connection. One for PC pass-through to allow co-location with a user PC.
- The phone includes a two-position desk stand. An optional wall mounting stand is available.
- The J100 Series phones support the following audio codecs on IP Office: G.711, G.726a, G.729, G.729a, G.729ab, G.722.
- Power via either PoE (Power over Ethernet). The phone is a PoE Class 1 device. An optional 5V power supply unit is available for locations where PoE is not available or suitable.
  - The phone changes to PoE Class 2 when using a button module or modules.
- Slot for an optional J100 wireless module. The module allows the phone to connect to the network using Wi-Fi and/or to use Bluetooth headsets.

### Related links

[Phone Overview](#) on page 13

---

## J189 Telephone

The J189 telephone is a SIP telephone supported on systems running Release 11.1 FP1 or higher software.



Features include:

- Dual displays:
  - Primary display:
    - 5" Color display (800 x 480).
    - 48 programmable button slots (buttons 1 to 48). The button slots can be arranged in single or two column pages (see [Single/Dual Column Display](#) on page 152).
    - 10 twin-LED (red and green) physical buttons are used to indicate the status of the programmable button slots currently in view.
  - Secondary display:
    - 2.4" Color display (240 x 320).
    - 24 programmable button slots (buttons 25 to 48 from the same pool as the primary display). The button slots are arranged in 4-pages of 6.
    - 6 twin-LED (red and green) physical buttons are used to indicate the status of the programmable button slots currently in view.
- 4 Additional buttons under the primary display. These are used for context-sensitive soft key functions. The buttons current function is indicated by the display label above it. See [Call Soft Keys](#) on page 28.

- Illuminated buttons for 📞 missed calls/call log, 🔊 speaker, 🎧 headset and 🤐 mute.
- Non-illuminated buttons for ✉ messages, 👤 contacts, 📞 phone and ☰ configuration menu access.
- Additional non-illuminated button for 📵 call drop.
- Call alerting/message waiting indication lamp.
- Dual 10/100/1000 Mbps Ethernet ports. One for phone network connection. One for PC pass-through to allow co-location with a user PC.
- The phone includes a two-position desk stand. An optional wall mounting stand is available.
- The J100 Series phones support the following audio codecs on IP Office: G.711, G.726a, G.729, G.729a, G.729ab, G.722.
- Power via either PoE (Power over Ethernet). The phone is a PoE Class 1 device. An optional 5V power supply unit is available for locations where PoE is not available or suitable.
- Slot for an optional J100 wireless module. The module allows the phone to connect to the network using Wi-Fi and/or to use Bluetooth headsets.
- Two USB Ports (USB-A and USB-C) supported for device charging and USB headset connection.

#### Related links

[Phone Overview](#) on page 13

---

## Button Modules

The addition of button modules allows the phone to support additional programmable buttons.

- Do not connect or disconnect a button module yourself. Your system administrator will arrange this if necessary. Failure to connect and restart the equipment in the correct order may cause the phone and or the button module to function incorrectly.
- The button modules are powered via the phone. Button modules can be powered by a phone using Power over Ethernet (PoE), this changes the phone from a Class 1 to a Class 2 device. However, to support more than two button modules, the phone must be powered by a J100 mains power supply unit rather than by PoE.
- There are 2 types of button module, JEM24 and JBM24. The different types cannot be combined on the same phone.

### JEM24 Button Modules

Each JEM24 has 24 dual-LED buttons with adjacent button label display. The button LED's are used to indicate the status of the button feature whilst pressing the button is used to access the feature.



The modules automatically match the display settings of the phone to which they are connected (color with J179 or greyscale with J169, font size, background image, screen saver).

- **J169/J179 Telephones**

- Both the J169 and J179 telephones can support up to 3 JEM24 button modules.
- A single JEM24 supports 72 programmable button slots. These are arranged in 3-pages, with pages accessed using the module's page scroll button. When in 3-page mode, there is no indication of when programmed button slots not on the page being displayed are altering.
- When multiple modules are connected to a phone, each module only supports a single page of 24 programmable button slots.

- **J189 Telephones**

- A J189 can support up to 2 JEM24 button modules.
- Each module provides the phone with an additional 24 programmable button slots in a single page. That is, the first module shows buttons 49 to 72, the second buttons 73 to 96. The page scrolling buttons on the modules are disabled.

### **JBM24 Button Modules**

Both the J169 and J179 telephones can support up to 3 JBM24 button modules. Each module provides the phone with 24 additional programmable buttons.

Each button has a 13 character display for the button label plus an adjacent dual-LED button. The button LEDs are used to indicate the status of the button feature whilst pressing the button is used to access the feature.

#### **Related links**

[Phone Overview](#) on page 13

---

## **The Phone Stand**

The phones all include a stand that clips to the base of the phone. The stand allows the phone to be used in either of two different angles.

When changing the position of the stand, be sure to check that the stand has locked into the chosen position.

#### **Related links**

[Phone Overview](#) on page 13

# Chapter 2: Phone Keys and Display

This section gives an overview of the keys and controls you will find on your phone.

## Related links

[Phone Keys](#) on page 26

[Call Soft Keys](#) on page 28



[Programmable Feature Buttons](#) on page 29

[Icons](#) on page 30







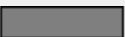

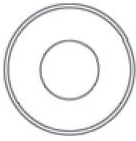

---

## Phone Keys

The following keys may be found on the phone (the keys can vary depending on the particular model of phone):





Key	Name	Description
 or 	<b>Appearance</b> or <b>Feature</b>	These keys have two roles: <ul style="list-style-type: none"><li>• <b>Appearance Buttons</b> – These buttons are used to make and receive calls. Each button represents a separate call. For example, the currently connected call to which you are talking, a held call and a new incoming call that is waiting to be answered. See <a href="#">Appearance Buttons</a> on page 35.</li><li>• <b>Feature Buttons</b> – Any other keys can be used for programmable feature buttons. The label next to the button indicates its function. You can reprogram some buttons, see <a href="#">Programmable Feature Buttons</a> on page 167.</li></ul>
	<b>Soft Keys</b>	The keys below the display have variable functions. When the key is active, its function is indicated by the text label that appears above it. See <a href="#">Call Soft Keys</a> on page 28.

*Table continues...*

Key	Name	Description
	<b>Cursor Keys</b>	This dial acts as a set of cursor key: <ul style="list-style-type: none"> <li>You can use the up and down cursor keys to scroll through lists.</li> <li>You can also use the left and right cursor keys to enter and exit different levels of the menu. Menu option that accesses a sub-menu is indicated by the ... dots (ellipsis) after its name or a &gt; symbol.</li> <li>When changing settings, the left and right cursor keys can sometimes be used to scroll through possible settings.</li> </ul>
	<b>OK Button</b>	This button, in the center of the cursor keys has multiple functions: <ul style="list-style-type: none"> <li>When the phone is idle, it can acts the same as going off-hook to dial.</li> <li>When on a call or in a menu, pressing it matches the function offered by the left-most soft key below the screen.</li> </ul>
	<b>MESSAGE</b>	This key is used to access your voicemail system. By default this uses a series of menus on your phone's display. See <a href="#">Voicemail</a> on page 112.
	<b>PHONE</b>	This key is used to exit any menu you are in and return to the phone's normal button display. During a call it can also be used to toggle the options displayed on the appearance menu.  It can also be used to leave the screen saver.
	<b>MAIN MENU</b>	This key is used to access a menu for phone settings and information. These are settings stored by the phone itself rather than the telephone system.
	<b>CONTACTS</b>	This key is used to display the various directories (personal and shared) of names and telephone numbers to which you have access. See <a href="#">Contacts</a> on page 95.
	<b>CALL LOG</b>	This key displays a record of your most recent calls (answered, missed, and outgoing). The button is illuminated when you have new missed calls. See <a href="#">Using the Call Log</a> on page 105.
	<b>VOLUME</b>	Press + plus or – minus ends of the key to adjust the volume. When the phone is idle, the button adjusts the ringer volume. When on a call, the button adjusts the caller volume on the handset, headset or speaker depending on which is being used at the time.
	<b>HEADSET</b>	This key is used to answer and end calls using a headset connected to the phone's headset socket. The button is lit when you are connected to a call using the headset.
	<b>MUTE</b>	This key can be used to mute your speech to the currently connected call. The button is lit while mute is active.
	<b>SPEAKER</b>	This key is used to answer and end calls using the phone's handsfree speaker and microphone. The button is lit when you are connected to a call handsfree.

## J159 Phones

J159 phones have a number of additional keys. These keys match functions that are also accessible via display soft keys.

Key	Name	Description
	<b>Conf</b>	This key can be used to start a conference call and to add additional calls to a conference. See <a href="#">Conferencing</a> on page 67.
	<b>Hold</b>	This key can be used to put the current call on hold. See <a href="#">Holding Calls</a> on page 59.
	<b>Redial</b>	This key can be used to redial a previous number. See <a href="#">Redialling</a> on page 54.
	<b>Transfer</b>	This key can be used to start and complete the process of transferring a call. See <a href="#">Transferring Calls</a> on page 56.

### J189 Phones

J189 phones have the following additional key.

Key	Name	Description
	<b>Drop</b>	This key affects the currently connected call regardless of the selected call on the phone display: <ul style="list-style-type: none"> <li>• If connected call, the call is ended.</li> <li>• If the call is held, the button has no effect.</li> <li>• If the call was part setting up a transfer or call conference, the setup process is cancelled and the original call reconnected.</li> </ul>

#### Related links

[Phone Keys and Display](#) on page 26

## Call Soft Keys

The functions performed by the buttons just below the display change dynamically. Each buttons current function is shown by the label (if any) above it on the display.

Note that the soft keys only relate to the call represented by the currently highlighted call. That does not necessarily have to be the connected call.

You can use the up and down cursor keys to change which call is currently highlighted and has its call details displayed without interrupting the connected call. This allows you to access the soft key options for that other call

The following are some of the common soft key options. Note that some soft key options are only be available if enabled by your system administrator.

Label	Function
<b>Account</b>	Enter an account code to associate with the call.
<b>Answer</b>	Answer a page call, turning it into a normal call.

*Table continues...*

Label	Function
<b>CallBack</b>	Set an automatic callback on the user that you have called but who has not answered. When they next end a call, the telephone system will call you and when answered, will automatically make a call to the user.
<b>Complete</b>	Complete the transfer of a held call. A <b>Cancel</b> option is also shown which will end the transfer attempt.
<b>Conf</b>	Put your current call on hold and present dial tone for you to dial the number you want to add to a conference with the held caller.
<b>Connect</b>	Take a call off hold.
<b>Dir</b>	Access the directory in order to select a number by name rather than dialing it. The type of names available in the directory is adjusted to match those suitable for use by the feature.
<b>Drop</b>	If you are connected to the call, this option ends the call. If the call is a personal call alerting, this option sends the call to your forward on busy number if set or else to your voicemail if enabled. If it is a hunt group call that is alerting, this option sends the call to the next member of the group.
<b>Ignore</b>	Silence the ringer for the current alerting call. The call will continue alerting until either answered, it goes to voicemail, or the caller abandons the call.
<b>Pickup</b>	Answer the call that is held or alerting another user.
<b>Redial</b>	If there are outgoing numbers in your call log, display the list of those numbers.
<b>Transfer</b>	Put your current call on hold and present dial tone for you to dial the number to which you want to transfer the call.
<b>ToVM</b>	Send an alerting call to your voicemail.

#### Related links

[Phone Keys and Display](#) on page 26

---

## Programmable Feature Buttons

Those programmable button not assigned as appearance buttons by your administrator can be used for a range of other features. Those other features can be programmed by you or by your system administrator.

- Your administrator can restrict which buttons you can change.
- This guide only covers those features that you may be able to assign through the phone's own menus. Your administrator has access to a larger range of button functions.
- The use of the button lamps depends on the feature assigned to the button.
- Buttons programmed with a feature that is not supported by the phone, display as **Invalid**.

For more details, see [Programmable Feature Buttons](#) on page 167.











#### Related links

[Phone Keys and Display](#) on page 26





## Icons

### Status Icons

The top lines of the display can include the following icons:











-  **Do Not Disturb** – This icon indicates that you have do not disturb enabled.
-  **Forward Unconditional** – This icon indicates that you have forward unconditional enabled.
-  **Ringer Quiet** – This icon indicates that the ringer volume has been set to zero.
-  **Volume Zero** – This icon indicates that the call volume (handset, speaker or headset) is set to zero.
-  **High Definition Audio** – The phone is using a high-definition audio connection.
-  **Wi-Fi Connection** (J159/J179/J189) – This icon is shown if the phone is connected to the network using Wi-Fi. The number of bars indicates the signal strength.
  -  **No Connection** – This icon indicates a loss of Wi-Fi signal or incorrect password.
-  **Bluetooth** (J159/J179/J189) – This icon is shown if the phone supports Bluetooth headset connection. See [Using Bluetooth Headsets](#) on page 127.
  -  **Headset Connected** – A dot within the icon indicates that the Bluetooth headset is connected.
-  **Connection Failure** – This icon indicates a connection issue.
  - If the phone has lost its connection to the telephone system, then if configured by your maintainer, after a few minutes it use a alternate system. If that is successful, an **R** (Resilience) is shown in the display.
-  **Missed Calls** – This icon indicates that you have had missed calls. The number next to the icon indicates the number of different callers. Pressing the button opens your call log at the missed calls display. See [Using the Call Log](#) on page 105.

### Call Log Icons

-  **Missed Callers** – This icon is shown at the top of the phone display if you have any missed callers. It also shows the number of missed callers or + if more than 9.
-  **Outgoing Call** – This icon indicates a call log entry for a call that was made by you.
-  **Incoming Call** – This icon indicates a call log entry for a call answered by you.
-  **Missed Call** – This icon indicates a call log entry for a call that altered at your phone but wasn't answered there.







## Appearance Button Icons

Your appearance buttons can display the following icons. When the icons are shown depends on the phone's display mode. In single-column mode the icons are always displayed. In dual-column mode, the icons are only shown when that button is alerting or being used.

-  **Off-Hook/Connected** – The appearance button is either being used to make a call or is connected on a call.
-  **Call Preservation** – There may be an issue with the other telephone system in your network that hosts the user or external trunk to which your call is currently connected. You may not be able to perform other call functions such as hold, park or transfer.
-  **Conference Call** – The appearance button is connected to a conference call.
-  **Alerting** – The appearance button has a call alerting.
-  **Busy** – The internal number you called is busy or not available.
-  **Call On Hold** /  **Conference on Hold** – You have an existing call on hold.
-  **Call On Hold Pending Transfer/Conference** – The call has been put on hold after you pressed **Transfer** or **Conf** to start the transfer or conference process.
-  **Idle** – The appearance button is not in use.
-  **Recording** – The call is being recorded. The system administrator can disable the display of this icon.
-  **Call Disconnected** – The far end of the call has disconnected. This may also appear if the system cannot route the number dialed.

## Other Icons

Whilst using the volume rocker at the bottom of the dial page to change the ringer volume or caller volume, the following icons indicate which volume you are adjusted:

-  **Ringer Volume** – This changes to a  icon if the volume is set to zero (the same icon then also appears in the status bar as a reminder that the ringer is now silenced).
-  **Handset Volume** /  **Headset Volume** /  **Speaker Volume** – This changes to  if the volume is set to zero (the same icon then also appears in the status bar as a reminder that the device is now silenced).

## Related links

[Phone Keys and Display](#) on page 26

# Chapter 3: Status Display

The top lines of the phone display shows information about you and your phone. For example:

- The top line shows the date and time plus various status icons.
- The next line shows information about the call/feature on the currently selected (outlined in white) button or your own extension/name if the button idle/unprogrammed. It can also display various status letter on the right-hand side.

## Related links

[Status Icons](#) on page 32







[Status Letters](#) on page 33

---





## Status Icons

### Status Icons

The top lines of the display can include the following icons:

-  **Do Not Disturb** – This icon indicates that you have do not disturb enabled.
-  **Forward Unconditional** – This icon indicates that you have forward unconditional enabled.
-  **Ringer Quiet** – This icon indicates that the ringer volume has been set to zero.
-  **Volume Zero** – This icon indicates that the call volume (handset, speaker or headset) is set to zero.
-  **High Definition Audio** – The phone is using a high-definition audio connection.
-  **Wi-Fi Connection** (*J159/J179/J189*) – This icon is shown if the phone is connected to the network using Wi-Fi. The number of bars indicates the signal strength.
-  **No Connection** – This icon indicates a loss of Wi-Fi signal or incorrect password.



-  **Bluetooth** (J159/J179/J189) – This icon is shown if the phone supports Bluetooth headset connection. See [Using Bluetooth Headsets](#) on page 127.
  -  **Headset Connected** – A dot within the icon indicates that the Bluetooth headset is connected.
-  **Connection Failure** – This icon indicates a connection issue.
  - If the phone has lost its connection to the telephone system, then if configured by your maintainer, after a few minutes it use a alternate system. If that is successful, an **R** (Resilience) is shown in the display.
-  **Missed Calls** – This icon indicates that you have had missed calls. The number next to the icon indicates the number of different callers. Pressing the button opens your call log at the missed calls display. See [Using the Call Log](#) on page 105.

### Related links

[Status Display](#) on page 32

---

## Status Letters

The top lines of the display can include the following status letters. These letter may appear as a group of letters, for example **OG** or **NG**.

	Description
<b>B</b>	<b>Barred</b> – The system administrator has prohibited you from making external calls. You can only make internal calls.
<b>G</b>	<b>In Group</b> – You have been configured as a member of a hunt group and your membership of the group is enabled. This means you may receive calls targeted to the hunt group. See <a href="#">Group Membership</a> on page 141.
<b>O</b>	<b>Out of Service</b> – A group of which you are a member is in night service mode. Calls to the group are diverted to its fallback if set or otherwise to voicemail if available. See <a href="#">Group Service Status and Fallback</a> on page 143
<b>R</b>	<b>Resilience</b> – Your phone is working in resilience mode. This is used when a problem with your telephone system or the connection to it means another system is providing support for your phone. In this mode, some features may not be available and calls may be routed differently.
<b>S</b>	<b>System Alarm</b> – If you are configured as a system administrator, this indicates a system alarm. See <a href="#">Reporting System Alarms</a> on page 185.
<b>T</b>	<b>Twinned</b> – Your phone is internally twinned with another extension. Calls to you alert on both phones and can be answered at either. See <a href="#">Twinning Button</a> on page 173.
<b>!</b>	<b>Cannot Retrieve Settings</b> – This indicates that the phone was not able to retrieve all your user settings. If this happens, it may limit some telephone functions. Contact your system administrator.

Status Display

**Related links**

[Status Display](#) on page 32

# Chapter 4: Appearance Buttons

Appearance buttons are used to represent calls made and received by you and other users on the telephone system. They are configured by your system administrator.

Normally, your first three buttons are call appearance buttons, but your administrator can configure additional appearance buttons for you if required.

Those buttons not programmed as appearance buttons can be programmed as feature buttons. See [Programmable Feature Buttons](#) on page 167.

There are several different types of appearance button:

- **Call Appearance Buttons** – These buttons are used to make and answer general calls.
- **Bridged Appearance Buttons** – This type of button mirrors another user's call appearance buttons and allows you to make and answer calls for a colleague.
  - This type of button is not supported on J139 phones.
- **Call Coverage Buttons** – Be alerted when a colleague has unanswered calls and answer those calls.
  - This type of button is not supported on J139 phones.
- **Line Appearance Buttons** – Make and answer external calls on a particular telephone line.

Which appearance button is currently selected and gets used when you go off-hook, for example by lifting the handset, is controlled by two system settings which are normally on by default. Those settings are:

- **Idle Line Preference** – Idle line preference automatically selects the first available call appearance or line appearance button as your currently selected button when you do not have a call connected. This means it will be the appearance button used when you go off hook. If this was not the case, you would need to select an appearance button before going off hook to make a call.
- **Ringing Line Preference** – If not connected to a call, when you receive an incoming call, ringing line preference automatically makes the alerting appearance button your selected appearance button. This means that you can answer the call by simply lifting the handset or pressing the **Headset** or **Speaker** button. Without ringing line preference, to answer the call on the alerting appearance button you must first press that appearance button to select it.

## Related links

[Call Appearance Buttons](#) on page 36

[Bridged Appearance Buttons](#) on page 37

[Call Coverage Buttons](#) on page 37

[Line Appearance Buttons](#) on page 37











## Call Appearance Buttons

Call appearance buttons are used to display calls to and from your phone. By having several call appearance buttons, you are able to answer and make several calls, switch between calls, and perform other actions.

When all your call appearance buttons are in use, any further calls to your number follow your 'forward on busy' setting, if set. Otherwise, calls go to voicemail (if available).

By default **a=**, **b=** and so on is displayed. This can be replaced by another label if required.

When the user is not connected to a call, the button indicated as selected is the button that will be used if the user goes off hook without pressing an appearance button. When a user is connected to a call, that call is the selected button.

LED	Red   Green	Name	Description
	Off   Off	Idle	The call appearance is not in use and is not currently selected.
	On   Off	Idle+Selected	As above but this is the current selected button that will be used if you go off hook.
	Off   Flash	Alerting	Alerting for an incoming call, accompanied by ringing. If already on a call, only a single ring is given.
	On   Flash	Alerting+Selected	As above but this is the current selected button that answered if you go off hook..
	On   On	In Use Here	You have a currently connected call or are dialing.
	Off   On	In Use Elsewhere	The call appearance button is in use on a bridged appearance.
	Off   Fast Flash	On Hold Here	You have put a call on hold.
	Both Fast Flash	On Hold Pending Transfer	
	Off   Intermittent Flash	On Hold Elsewhere	A call on a bridged appearance button matched to the call appearance has been put on hold.
	Off   Broken Flash	Invalid	The button is not programmed for any function.

### Related links

[Appearance Buttons](#) on page 35

---

## Bridged Appearance Buttons

A bridged appearance button shows the state of one of another user's call appearance buttons. It can be used to answer or join calls on that other user's call appearance button.

It can also be used to make a call that the call appearance user can then join or retrieve from hold.

- When the user's call appearance button alerts, your matching bridged appearance button also alerts. The bridged appearance button can be used to answer the call on the call appearance button user's behalf.
- When the call appearance button user answers or makes a call using that call appearance, your matching bridged appearance button shows the status of that call, for example connected, on hold, etc. The bridged appearance button can be used to retrieve the call if on hold or to join the call if active.
- Bridged appearance buttons are not supported between users on different systems in a network.
- This type of button is not supported on J139 phones.

### Related links

[Appearance Buttons](#) on page 35

---

## Call Coverage Buttons

Each call coverage button is associated with another user on your telephone system. The button allows you to be alerted when that user has an unanswered call still ringing.

You can view the details of the call and answer it if required.

The settings of the user being covered control how long it rings at their phone before it also starts alerting on your call coverage button for that user.

Call coverage appearance buttons are not supported between users on different systems in a network.

- This type of button is not supported on J139 phones.

### Related links

[Appearance Buttons](#) on page 35

---

## Line Appearance Buttons

Line appearance buttons allow you to make and receive calls on a specific telephone line connected to your telephone system. The button also allows you to see when the line is in use by other users.

## Appearance Buttons

For incoming calls, the telephone system still determines the destination for the call. That may be a user or group. However, if you have a line appearance button for the line, you will see that there is a call alerting and can answer it if required.

- **Private Lines** – Special behavior is applied to calls when you are the system's default destination for a line for which you have a line appearance button. In that case, incoming calls on that line will alert only on the Line Appearance button and not on any other buttons. These calls will also not follow any forwarding.

### Related links

[Appearance Buttons](#) on page 35

# Part 2: Making and Answering Calls

# Chapter 5: Making Calls

The phone provides a number of ways to make calls.

At its simplest, just dial the number required. When answered, continue handsfree or lift the handset if required.

## Related links

- [Making a Call](#) on page 40
- [Making Additional Calls](#) on page 41
- [Calling from Your Contacts](#) on page 41
- [Calling from the Call Log](#) on page 42
- [Redialling a Previous Number](#) on page 43
- [Making a Page Call](#) on page 44
- [Busy Indication](#) on page 44
- [En-Bloc Dialing](#) on page 45
- [Withholding Your Number](#) on page 46
- [Adjusting the Call Volume](#) on page 46
- [Muting a Call](#) on page 47
- [Ending Calls](#) on page 47

---

## Making a Call

If you are not already on a call, then you can just dial the number.

### Procedure

With no connected call, start dialing:

- The first available appearance button is automatically selected for the call.
- The call uses either the phone's speaker or headset depending on the phone's default handsfree audio setting. To switch to the handset, just lift the handset.
- If the number you dial matches a user or group on the telephone system, the directory name is shown and the call starts altering them. Otherwise, as soon as there are enough digits the phone will be connected to an external telephone line.
- If the call is to an internal user, and they do not answer, you can set a callback by pressing **CallBack** and then ending the call by pressing **Drop**. When a callback is set, the next time a



user uses their phone or ends their current call, the system will call you and when you answer, automatically make another call to the user.

#### Related links

[Making Calls](#) on page 40

---

## Making Additional Calls

If you are already on a call, you can still make and answer other calls.

### Procedure

1. Either:
  - Simply press any idle call appearance key. For example, **b=**.
  - Press the **Hold** soft key.
2. The existing call is automatically put on hold, shown by a fast flashing green lamp.
3. Make the additional call as normal.
4. Once the additional call is connected:
  - You can press the appearance buttons to switch between calls.
  - Press **Conf** to conference the calls together.

#### Related links

[Making Calls](#) on page 40

---

## Calling from Your Contacts

You can use any directory contact to make a call.

- You can also use the directory to select a contact anytime the **Dir** soft key is displayed in the function's menus. In that case, the system automatically only shows the types of contacts supported for the function.

### Procedure

1. Access the contacts directory:
  - a. Press the **CONTACTS** key. The directory menu is displayed.
  - b. Use the left and right cursor keys to select the type of directory entries shown.
    - **All** - All directory entries.
    - **Personal** - Your own personal directory entries.

- **External** - Directory entries stored by the telephone system for all users to use.
  - **Users** - The names and numbers of other users on the telephone system.
  - **Groups** - The names and numbers of hunt groups on the telephone system.
- a. Use the up and down cursor keys to scroll through the list. Alternatively, you can start dialing the name you want to display only matching entries as follows:
    - Pressing a key enters all of the characters represented by that key. Pressing another key adds the characters from that button to the previous key press.
    - For example, dialing **527** matches all names starting with **JAS** (for example "Jason") and with **KAR** (for example "Karl") plus any other letter combinations from those 3 key presses. See [How the Directory Search Works](#) on page 96.
    - To remove all the characters entered so far, press **Clear**.
  - b. To view more details of the highlighted name, press **Details**. To return to the directory press **List**.
2. When the required entry is highlighted, press **Call** or press the  button next to the name.
  3. Proceed as you would with a normally dialed call.

#### Related links





[Making Calls](#) on page 40

---

## Calling from the Call Log

You can use your call log to make calls.

### Procedure

1. Access your call log:
  - a. Press the  **CALL LOG** button.
    - If you have any new missed calls, the button is illuminated and opening the call log shows missed calls.
  - b. Use the left/right cursor keys to select the type of records shown: **All**,  **Outgoing**,  **Incoming** and  **Missed**.
  - c. Use the up/down cursor keys to scroll through the records.
2. Press **Call** to call the number displayed in the call record. This option is not available if the caller withheld their number.

#### Related links

[Making Calls](#) on page 40

---

## Redialling a Previous Number

When **Redial** is displayed it can be used to make a call to a previously used number. Redial can work in one of two ways, set by your choice of redial mode see [Selecting Your Redial Mode](#) on page 55.

### Related links

[Making Calls](#) on page 40

[Redialling in List Mode](#) on page 43

[Redialling in Last Number Mode](#) on page 43

[Redialling](#) on page 54

---

## Redialling in List Mode

This redial method is used when your phone's redial mode is set to **Open Call Log**.

### Procedure

1. Access the redial list:
  - a. Press **Redial**. The list of outgoing calls is displayed.
  - b. Use the up and down cursor keys to scroll through the 10 most recent outgoing calls.
2. Press **Call** to call the number displayed in the call record.
3. Continue in the same way as for a normal dialed call.

### Related links

[Redialling a Previous Number](#) on page 43

[Redialling](#) on page 54

---

## Redialling in Last Number Mode

This redial method is used when your phone's redial mode is set to **Last Dialed**.

### Procedure

1. Press **Redial**.
2. The number for the most recent outgoing call in your personal call log is redialed.
3. Continue in the same way as for a normal dialed call.

### Related links

[Redialling a Previous Number](#) on page 43

---

## Making a Page Call

In order to make page calls you must have access to a paging short code provided by the system administrator or a **Page** feature button.

You can use the self-administration function to assign one of your phone's feature buttons as a **Page** button. See [Programmable Feature Buttons](#) on page 167.

- If the short code or the paging button have been pre-configured with an extension number, the user or group at that number is paged if available.
- If the short code of paging button does not have a pre-configured extension number, it allows extension number entry when used.

### Procedure

1. Press the paging button.
2. Dial the number of the user or group you want to page.
3. When the dialing is completed, the page call is made.

### Related links

[Making Calls](#) on page 40

---

## Busy Indication

By default, when making internal calls, the telephone system does not provide any indication if the internal user you call is available, already on a call or set to do not disturb. Instead the call either just rings or goes to voicemail.

However, there are various methods by which you can get some indication of their status:

- If you need status indication for a user without needing to make a call, you can add a 'user ' button to your phone. See [Programmable Feature Buttons](#) on page 167
- Other users can configure an absence message. If they have done that, the message is displayed on your phone when you call them. To set your own absence message, you can use a programmable set to the **Absence Text** button. See [Programmable Feature Buttons](#) on page 167.
- Your system administrator can enable busy indication for selected users or for the whole system. When enabled, calling those users displays **Do Not Disturb** or **On Another Call** on your phone if the call is not diverted to voicemail.

### Related links

[Making Calls](#) on page 40

---

## En-Bloc Dialing

Through the phone's menus you can select whether you want to use traditional or en-bloc dialing when making calls. Your chosen setting is then applied whenever you use a phone that supports en-bloc dialing.

- En-bloc dialing allows you to compose and edit the number to dial on your phone's display before it is sent to the phone system to be dialed.
- With traditional dialing, when you start dialing a number on your phone, the phone immediately connects to the telephone system and starts passing the digits you dial to the phone system. You cannot correct the digits you have already dialed except by ending the call and starting over.

### Related links

[Making Calls](#) on page 40



[Dialing a Number in En-Bloc Mode](#) on page 45

[Enabling/Disabling En-Bloc Dialing](#) on page 45

---

## Dialing a Number in En-Bloc Mode

### Procedure

1. With no connected call, start dialing. Do not lift the handset or select the headset, speaker or an appearance button before dialing:
  - You can use the left cursor key or the **Bksp** key to delete the previous digit dialed.
  - Press **Clear** to erase the whole number dialed so far.
2. When you have completed the number, you can select how you want to make the call:
  - Lift the handset to make a call using the handset.
  - Press the **Call** soft key or **OK** button to start the call using the phone's default handsfree audio path (speaker or headset). You can also press one of your idle call appearance buttons to make the call using that appearance.
  - Press the  **HEADSET** button to start the call on a headset connected to your phone.
  - Press the  **SPEAKER** button to start the call on your phone's handsfree speaker.

### Related links

[En-Bloc Dialing](#) on page 45

---

## Enabling/Disabling En-Bloc Dialing

You can enable or disable your en-bloc dialing setting through the phone's **Features** menu.

## Procedure

1. Press the **Features** soft key if shown.
  - To do this during a call, press the  **PHONE** key and then press **Features**.
2. Use cursor keys to select **Call Settings**.
3. Use the up and down cursor keys to highlight **Enbloc Dial**.
4. Press the **Change** button to select **On** or **Off**.
5. Press **Save**.

## Related links

[En-Bloc Dialing](#) on page 45

---

# Withholding Your Number

You can select to withhold your number on external calls.

- Your system administrator can configure whether you can access this menu.
- This menu is not supported on the J139.

## Note:

- Use of this option depends on the external line provider. In some cases, attempting to use this feature can cause calls to fail. If this occurs, the feature should be switched off.

## Procedure

1. Press the **Features** soft key if shown.
  - To do this during a call, press the  **PHONE** key and then press **Features**.
2. Use cursor keys to select **Call Settings**.
3. Use the up and down cursor keys to highlight **Withhold Number**.
4. Press the **Change** button to select **On** or **Off**.
5. Press **Save**.

## Related links

[Making Calls](#) on page 40

---

# Adjusting the Call Volume

Whilst talking, you can adjust the volume of the incoming call. The volume is adjusted separately for whichever device is in use (handset, headset or speaker).

### Procedure

1. With the call connected, use the **+** plus and **-** minus keys to adjust the volume.
2. The display returns to normal after a few seconds.

### Related links

[Making Calls](#) on page 40



---

## Muting a Call

Muting a call stops the caller from hearing you, however you can still hear them.

- Calls remain muted even if you switch between calls.
- Calls remain muted even if you change how you are listening to the call. For example, switching between the handset and speaker.

### Procedure

1. To activate mute, press the  **MUTE** key. The button is lit whilst the call is muted.
2. To switch mute off, press the  **MUTE** key again.

### Related links



[Making Calls](#) on page 40

---

## Ending Calls

### Procedure

There are multiple methods that can be used to a call. Either:

- To end the call currently highlighted on the display, press the **Drop**.
- To end the call connected on the phone's handset, replacing the handset ends the call.
- To end the call connected on the phone's speaker, press the  **SPEAKER** key.
- To end the call connected on the phone's headset, press the  **HEADSET** key.
- On the J189, to end the currently connected call, press the  key.

### Related links

[Making Calls](#) on page 40

# Chapter 6: Answering Calls

Your phone lets you handle multiple calls at the same time. Whilst you can only have one call connected (talking) at any moment, you can have other calls waiting to be answered and further calls on hold.

Each call appears on one of the phone's appearance buttons, see [Appearance Buttons](#) on page 35. The system doesn't treat you as busy to further calls until all your available call appearance buttons are in use.

## Related links

[Answering a New Call](#) on page 48

[Answering Another Call](#) on page 49

[Diverting a Call to Voicemail](#) on page 50

[Silence \(Ignore\) an Alerting Call](#) on page 50

[Dropping an Incoming Call](#) on page 50

[Page Calls](#) on page 51

[Displaying Other Calls](#) on page 51

[Using Call Pickup](#) on page 52

[Call Pickup Short Codes](#) on page 53



---

## Answering a New Call





A slow flashing red lamp on an appearance button indicates an alerting call. This may also be accompanied by ringing and by the message lamp flashing.

- **Note:** This guide assumes that auto hold is enabled (the default). The system administrator can disable auto hold for the system, in which case calls are automatically disconnected rather than held.

### Procedure

1. If you are not already on a call, you can answer the alerting call in the following ways:
  - To answer the call using the handset, lift the handset.
  - To answer the call handsfree, press the  **SPEAKER** key.
  - To answer the call on a headset, press the  **HEADSET** key.



- Just pressing the alerting appearance key answers the call either on the speaker or headset depending on the phone's default audio path setting. See [Default Handsfree Audio Path](#) on page 165.
2. Once you have answered the call, you can switch between different talk modes:
    - To switch to using the handset, lift the handset.
    - To switch to handsfree, press the  **SPEAKER** key. If you were using the handset you, can now safely replace it.
    - To switch to headset mode, press the  **HEADSET** key. If you were using the handset, you can now safely replace it.
    - If you have answered the call on the speaker or headset, pressing the  **SPEAKER** or  **HEADSET** key again before you select another mode ends the call.
    - Just pressing the call appearance key or any other appearance button puts the current call on hold.

#### Related links

[Answering Calls](#) on page 48

---

## Answering Another Call

Your phone lets you handle multiple calls at the same time. Whilst you can only have one call connected (talking) at any time, you can have other calls on hold.

A slow flashing red lamp on an appearance button indicates an alerting call. For additional calls, there is no ringing or just a single alert tone.

If you are already on a call, answering a new call automatically put that existing call on hold unless your first press **Drop**.

- **Note:** This guide assumes that auto hold is enabled (the default). The system administrator can disable auto hold for the system, in which case calls are automatically disconnected rather than put on hold.

### Procedure

1. To answer the waiting call, press the appearance key indicating the new call. The new call is answered and your existing call is automatically put on hold.
2. You can switch between calls by pressing the appearance button of the call to which you want to speak.
3. The soft key functions shown relate to the call which is currently highlighted. Normally that is the call just answered or represented by the last appearance key pressed, but using the cursor keys below the display you can change which call is highlighted whilst still remaining connected to your current call.

### Related links

[Answering Calls](#) on page 48

---

## Diverting a Call to Voicemail

You can transfer a call targeted at you directly to your voicemail mailbox.

### Procedure

1. If the call is not the currently highlighted call on the display, use the up and down cursor keys to highlight it.
2. Press the **ToVM** soft key. The call is redirected to your mailbox.

### Related links

[Answering Calls](#) on page 48

---

## Silence (Ignore) an Alerting Call

You can silence the ringer of a currently alerting call.

### Procedure

1. If the call is not the currently highlighted call on the display, use the up and down cursor keys to highlight it.
2. Press the **Ignore** soft key. The call continues alerting but with no audible ring.

### Related links

[Answering Calls](#) on page 48

---

## Dropping an Incoming Call

You can attempt to drop an incoming call rather than answering it. Doing this has different effects depending on the call type and other options:

- If the call is a hunt group call, dropping the incoming call causes it to be presented to the next agent in the group or follow other hunt group settings (which can include presenting the call to you again).
- If the call is a direct call to you, dropping it causes it to:
  - Go to your forward on no answer destination if set and enabled. See [Forwarding Calls](#) on page 76.

- Else, the call goes to your voicemail if available.
- Else, the call continues to ring (drop has no effect).
- If the call is returning from being held or parked for too long, you cannot drop it.

### Procedure

1. If the call is not the currently highlighted call on the display, use the up and down cursor keys to highlight it.
2. Press the **Drop** key. You can also assign the drop function to a programmable key. See [Programmable Feature Buttons](#) on page 167.

### Related links

[Answering Calls](#) on page 48

---

## Page Calls

Your phone can be paged if you have no other connected call in progress and your phone is currently idle. You can hear the caller but they cannot hear you.

The page is heard through the phone's speaker following a single beep. A page call is also indicated in the display by the word **Page**.

- To answer the page call, press the **Answer** key. The call is turned into a normal call. You can continue handsfree or pickup the handset.
- To ignore the page call, press the **Drop** key.

### Related links

[Answering Calls](#) on page 48

---

## Displaying Other Calls

The phone can handle multiple calls at the same time. Whilst you can only have one connected call at any time, you can have other calls on hold, parked and further incoming calls alerting. The status of each call (except parked calls) is indicated by a separate call appearance button for each call.

Changing the currently displayed call before starting a conference affects which calls are conferenced. See [Context Sensitive Conferencing](#) on page 71.

## Procedure

Use the up and down cursor keys to select which call appearance is highlighted. This can be done without affecting any currently connected or held calls.

- The currently highlighted button is shown by a white border around the button label.
- The soft keys at the bottom of the display automatically change to reflect actions that can be performed on the call, if any, associated with the currently highlighted button.

## Related links

[Answering Calls](#) on page 48

---

# Using Call Pickup

Pickup is used to answer a call ringing elsewhere on the phone system.

## \* Note:

- Your system administrator can configure whether you can access this menu.
- This menu is not supported on the J139.

## Procedure

1. Press the **Features** soft key if shown.
  - To do this during a call, press the  **PHONE** key and then press **Features**.
2. Use the cursor keys to select **Pickup**.
  - To answer any ringing call, press the **Any** soft key.
  - To answer a call ringing against a particular target, dial the target's number. Alternatively, press the **Dir** soft key to select the target from the directory.
3. The menu then depends on the type of number entered:
  - **User Number**
    - To answer a call ringing against the user, press the **Pickup** soft key.
    - To return to entering a number, press the **Clear** key.
  - **Hunt Group Number**
    - To answer a call ringing against the members of the group, press the **Members** soft key. The call does not have to be a call to the hunt group.
    - To answer a call ringing for the hunt group, press the **Group** soft key.
    - To return to entering a number, press the **Clear** key.

## Related links

[Answering Calls](#) on page 48

---

## Call Pickup Short Codes

Short codes are numbers that you can dial to enable and disable various features. The following are default short codes that may be available. However, your system administrator can remove and change the short codes available to you or all users. To use a short code, you may have to put your currently call on hold.

These are useful as they can be dialed from any phone on the system. For example, this allows you to login at a basic analog extension and still control a number of features.

Some short codes require you to enter some information when you dial them, typically an extension number. That is indicated by **N** in the short codes shown below.

- For a list of other common dialing short codes, see [Short Codes](#) on page 176.

### Call Pickup

- **Pickup Any Call: \*30** – Answer a call ringing on the telephone system.
- **Pickup a Group Call: \*31** – Answer a call ringing a group of which you are a member. You can use this even if your group membership is currently set to disabled.
- **Pickup a Users Call: \*32\*N#** – Pickup a call ringing a user's extension number (**N**).
- **Pickup a Group Members Call: \*53\*N#** – Pickup a call ringing the members of a group (**N**). This does not necessarily have to be a group call.

### Related links

[Answering Calls](#) on page 48

# Chapter 7: Redialling

The phone's redial operation works in one of the following modes:

- **Open Call Log** – In this mode, pressing **Redial** displays a list of your most recent outgoing calls. You can select the call that you want to redial from the list.
- **Last Dialed** – In this mode, pressing **Redial** immediately repeats your most recent outgoing call.

In either case, the redial function uses the outgoing call records in your personal call log. If you delete the records in your call log (see [Deleting the Whole Call Log](#) on page 109), redial will not work until new outgoing call records exist.

- On J159 telephones, in addition to the **Redial** soft key, conference functions can be accessed using the **5** key.

## Related links

[Redialling in List Mode](#) on page 43

[Redialling a Previous Number](#) on page 43

[Selecting Your Redial Mode](#) on page 55

---

## Redialling in List Mode

This redial method is used when your phone's redial mode is set to **Open Call Log**.

### Procedure

1. Access the redial list:
  - a. Press **Redial**. The list of outgoing calls is displayed.
  - b. Use the up and down cursor keys to scroll through the 10 most recent outgoing calls.
2. Press **Call** to call the number displayed in the call record.
3. Continue in the same way as for a normal dialed call.

## Related links

[Redialling a Previous Number](#) on page 43

[Redialling](#) on page 54

---

## Redialling a Previous Number

When **Redial** is displayed it can be used to make a call to a previously used number. Redial can work in one of two ways, set by your choice of redial mode see [Selecting Your Redial Mode](#) on page 55.

### Related links

[Making Calls](#) on page 40

[Redialling in List Mode](#) on page 43

[Redialling in Last Number Mode](#) on page 43

[Redialling](#) on page 54

---

## Selecting Your Redial Mode

You can select whether your phone uses the redial list or last call redial mode.

### Procedure

1. Press the **Features** soft key if shown.
  - To do this during a call, press the  **PHONE** key and then press **Features**.
2. Use cursor keys to select **Call Settings**.
3. Use the up and down cursor keys to highlight **Redial Action**.
4. The current mode is displayed:
  - **Open Call Log** – In this mode, pressing **Redial** displays a list of your most recent outgoing calls. You can select the call that you want to redial from the list.
  - **Last Dialed** – In this mode, pressing **Redial** immediately repeats your most recent outgoing call.
5. To change the mode, press **Change**.
6. When the desired mode is displayed, press **Save**.

### Related links

[Redialling](#) on page 54

# Chapter 8: Transferring Calls

You are able to transfer calls even if all your current call appearance buttons are in use.

- **Calls and Button Status Indication:**

The status indication for a call on hold pending transfer differs from that used for standard held calls:

- Both the green and red lamps fast flash (flutter) when the button represents a call on hold pending transfer.
- The call status information shown when a call on hold pending transfer is highlight is prefixed with **On-Hold-Xfer** rather than **On-Hold**.

- **Switching Between Calls:**

Switching from a connected call to an existing call on hold pending transfer puts the connected call on hold pending transfer.

- On J159 telephones, in addition to the **Transfer** soft key, transfer functions can be accessed using the  key.

## Procedure

1. Press **Transfer**. The current call is automatically put on hold pending transfer.
2. Dial the number for the transfer.
  - Alternatively, press **Dir** to select a destination from the directory or use the **Redial** option, if applicable.
3. If the transfer destination does not answer or does not want to accept the call, press the **Transfer** soft key.
4. To complete the transfer, press **Complete** . You can do this while the call is still ringing.
  - Transferring a call while it is still ringing is called an unsupervised transfer.
  - Transferring a call after ringing finishes is called a supervised transfer.

## Related links

[Transferring a Call to Voicemail](#) on page 57

[Transferring a Held Call](#) on page 57

[Transferring a Call to Your Mobile](#) on page 58



---

## Transferring a Call to Voicemail

When set to visual voice mode, the **MESSAGE** key can be used to transfer your current call to the voicemail mailbox of another user or group.

### Procedure

1. With the call connected, press the **MESSAGE** key. You are still connected to the call and can continue talking.
2. Dial the extension number of the user or group to which you want to transfer the call.
3. When the number matches a user or group, their name is displayed.
  - To transfer the call to the user or group's mailbox, press **Select**. The caller hears a few seconds of ringing and then the mailbox greeting.
  - To cancel the transfer, press **Cancel**.

### Related links

[Transferring Calls](#) on page 56

---

## Transferring a Held Call

There are various call transfer scenarios to consider:

- **Note:** It is also possible to transfer a held call by starting a conference and then dropping yourself from that conference. However, if you are the only internal user in the conference, depending on your telephone system's configuration, dropping yourself might end the conference.

### Procedure

1. **Transfer to a Held Call:** If you have multiple calls on hold and you want to transfer a connected call to one of the held calls:
  - a. Press the **Transfer** soft key and use the up and down cursor keys to highlight the desired call appearance.
  - b. When you are satisfied, press **Complete** to transfer the call while the other held call(s) remain on hold.
2. **Transfer to a New Call:** If you have calls on hold but you want to connect your current call with a new destination:
  - Press the **Transfer** soft key and enter the destination manually using the numerical keypad and press **Complete**.
  - Alternatively, press **Dir** to select a destination from the directory or use the **Redial** option, if applicable.

3. **Consult the Caller Before Transferring:** If you have a destination call connected but you wish to refer back to the originating call before completing the transfer:
  - a. Do NOT press **Complete** to transfer the destination call as in scenario #2.
  - b. Select the originating call ('on hold pending transfer') by pressing its call appearance button. This places the destination call 'on hold pending transfer' so that you can notify the originating caller.
  - c. With the originating call connected, you can now press **Complete** to connect the two calls.
  - d. Held calls that are not pending transfer are not affected. Moreover, it is not possible to have more than one call 'on hold pending transfer'.

**Related links**

[Transferring Calls](#) on page 56

[Holding Calls](#) on page 59

---

## Transferring a Call to Your Mobile

If you have been configured as a mobile twinning user, you can transfer a call to your mobile device using the features menu.

**Procedure**

1. Press the **Features** soft key if shown.
  - To do this during a call, press the  **PHONE** key and then press **Features**.
2. Use the cursor keys to select **Transfer to Mobile**.

**Related links**

[Transferring Calls](#) on page 56

# Chapter 9: Holding Calls

You can hold one or more calls.

- The held call still occupies the appearance button on which it was made or answered. A fast flashing green lamp is used to indicate held calls.
- The caller hears music on hold. If your system does not have music on hold available, the caller hear double beep tones every few seconds.
- If you have more than one held call, or one held call and a connected call, pressing the **Conf** soft key starts a conference between yourself and the calls.
- On J159 telephones, in addition to the **Hold** soft key, conference functions can be accessed using the **||** key.

Holding a call and parking a call are two similar actions. The table below summarizes the main differences between parking a call and holding a call.

When used to park or hold a call...	Hold	Park
... the call occupies an appearance button.	Yes	No
... the caller hears music on hold if available.	Yes	Yes
... the call can be retrieved by other users dialing a short code.	No	Yes
... the call recalls you automatically if your phone is idle.	Yes	Yes
... can be used with conference calls.	Yes	Yes
... can be used to start or add calls to a conference.	No	No
... the call is assigned a unique ID.	No	Yes

## Related links

[Holding Conference Calls](#) on page 59

[Holding a Call](#) on page 60

[Taking a Call Off Hold](#) on page 60

[Switching Between Calls](#) on page 61

[Transferring a Held Call](#) on page 57

---

## Holding Conference Calls

You can hold a conference call in the same way as holding a normal call. Holding the conference call does not affect the other conference parties who can continue talking.

You are also still listed as a member of the conference call in the conference details.

**!** **Important:**

This only applies to conference calls hosted by your own telephone system. Holding your call to a conference hosted on another telephone system may cause that conference to hear your system's music on hold.

**Related links**

[Holding Calls](#) on page 59

---

## Holding a Call

### Procedure

To put your current call on hold, press the **Hold** soft key or the call's appearance button.

- The held call is indicated by its call appearance button with a fast-flashing green lamp.
- The phone displays **On-Hold** before the call information.
- The held call displays a  icon.
- Whilst held, the caller hears music on hold. If your system does not have music on hold available, the caller hears double beep tones every few seconds.

**Related links**

[Holding Calls](#) on page 59

---

## Taking a Call Off Hold

Either of the following methods can be used to retrieve a call from hold. If you have a currently connected call, that call is automatically put on hold.

### Procedure

1. Press the appearance button with the fast-flashing green call appearance.
2. Scroll the display using the up/down cursor keys. To take the call off hold, press the **Cancel** soft key.

**Related links**

[Holding Calls](#) on page 59

---

## Switching Between Calls

With a call on hold (fast-flashing appearance button) and another call connected (red call appearance button), you can switch between calls by pressing the appearance button of the held call. The current call is automatically put on hold and the previously held call is connected.

When you place a call on hold in order to make a transfer, the call is considered '*on hold pending transfer*' and is indicated by fast-flashing red *and* green appearance buttons.

### Related links

[Holding Calls](#) on page 59

---

## Transferring a Held Call

There are various call transfer scenarios to consider:

- **Note:** It is also possible to transfer a held call by starting a conference and then dropping yourself from that conference. However, if you are the only internal user in the conference, depending on your telephone system's configuration, dropping yourself might end the conference.

### Procedure

1. **Transfer to a Held Call:** If you have multiple calls on hold and you want to transfer a connected call to one of the held calls:
  - a. Press the **Transfer** soft key and use the up and down cursor keys to highlight the desired call appearance.
  - b. When you are satisfied, press **Complete** to transfer the call while the other held call(s) remain on hold.
2. **Transfer to a New Call:** If you have calls on hold but you want to connect your current call with a new destination:
  - Press the **Transfer** soft key and enter the destination manually using the numerical keypad and press **Complete**.
  - Alternatively, press **Dir** to select a destination from the directory or use the **Redial** option, if applicable.
3. **Consult the Caller Before Transferring:** If you have a destination call connected but you wish to refer back to the originating call before completing the transfer:
  - a. Do NOT press **Complete** to transfer the destination call as in scenario #2.
  - b. Select the originating call ('on hold pending transfer') by pressing its call appearance button. This places the destination call 'on hold pending transfer' so that you can notify the originating caller.
  - c. With the originating call connected, you can now press **Complete** to connect the two calls.

## Holding Calls

- d. Held calls that are not pending transfer are not affected. Moreover, it is not possible to have more than one call 'on hold pending transfer'.

### Related links

[Transferring Calls](#) on page 56

[Holding Calls](#) on page 59

# Chapter 10: Parking Calls

Parking a call is similar to holding a call. However, parked calls can be unparked by other users on the phone system.

Each parked call is given a number. By default, the number is your extension number plus a digit.

Calls that you park return to your phone (when idle) if they remain parked for too long. The default return delay is five minutes. This is a system delay that is applied to all users and can be changed by the system administrator. Returning calls ignore any forwarding or do not disturb settings.

A feature button set to the **Call Park** action can be used to park and unpark calls and to indicate parked calls.

Holding a call and parking a call are two similar actions. The table below summarizes the main differences between parking a call and holding a call.

When used to park or hold a call...	Hold	Park
... the call occupies an appearance button.	Yes	No
... the caller hears music on hold if available.	Yes	Yes
... the call can be retrieved by other users dialing a short code.	No	Yes
... the call recalls you automatically if your phone is idle.	Yes	Yes
... can be used with conference calls.	Yes	Yes
... can be used to start or add calls to a conference.	No	No
... the call is assigned a unique ID.	No	Yes

## Related links

[Parking Short Codes](#) on page 63

[Parking Calls \(Features Menu\)](#) on page 64

[Unparking Calls Using the Status Menu](#) on page 64

[Park & Page](#) on page 65

---

## Parking Short Codes

Short codes are numbers that you can dial to enable and disable various features. The following are default short codes that may be available. However, your system administrator can remove and change the short codes available to you or all users. To use a short code, you may have to put your currently call on hold.

These are useful as they can be dialed from any phone on the system. For example, this allows you to login at a basic analog extension and still control a number of features.

Some short codes require you to enter some information when you dial them, typically an extension number. That is indicated by **N** in the short codes shown below.

- For a list of other common dialing short codes, see [Short Codes](#) on page 176.

### Park/Unpark

- **Park Call: \*37\*N#** – Parks the held call using the park number dialed in place of **N**.
- **Unpark Call: \*38\*N#** – Unpark the call parked using the park number **N**.

### Related links

[Parking Calls](#) on page 63

---

## Parking Calls (*Features Menu*)

- This menu is not supported on the J139.
- Your system administrator can configure whether you can access this menu.

### Procedure

1. Press the **Features** soft key if shown.
  - To do this during a call, press the  **PHONE** key and then press **Features**.
2. Use the cursor keys to select one of the following:
  - **Call Park** – Park the call on the system with parked call indication on your phone
  - **Call Park To Other** – Park the call on the system with parked call indication on another selected extension.
3. Press **Select**.

### Related links

[Parking Calls](#) on page 63

---

## Unparking Calls Using the Status Menu

While parked calls are parked on the telephone system and can be unparked by any other user, the parked call indication is sent to a particular extension. If there are any calls parked against your phone, you can view and unpark them via the **Status** menu.

- Your system administrator can configure whether you can access this menu.
- This menu is not supported on the J139.



## Procedure

1. Press the **Status** soft key if shown.
  - To do this during a call, press the  **PHONE** key and then press the **Status** soft key.
2. If you have any parked calls, the **Parks...** option is displayed. The option is not present if you do not have calls parked against your extension.
3. Press the **Details** soft key.
4. Use the cursor keys to scroll through the parked calls.
5. To unpark a particular call, highlight it and then press the **Connect** soft key.

## Related links

[Parking Calls](#) on page 63

---

## Park & Page

This method of parking calls is available only if specifically configured on your telephone system. To use it, you also need to add a **Park and Page** button on your phone. See [Programmable Feature Buttons](#) on page 167.

- Park and page uses a set of park slot numbers, configured by your system administrator, that act like extension numbers.
- When you parked a call in one of those park slots, you or any other user on the system can dial that park slot number to unpark the call.
- Your system administrator can also configure up to 3 hunt groups for paging. When you park a call, after displaying the park slot number used, your phone displays options for paging.
- Calls parked using Park & Page are not indicated in your phone's **Status** menu. However, calls that you park recall to your phone if left parked for too long.
- If your phone has any **Call Park** buttons set to match the park slot numbers configured for Park & Page, those buttons indicate when a call is parked in that park slot and can be used to unpark it. However, when used to park a call, the phones does not display the page options.

## Procedure

1. Press the **Park and Page** button on your phone. The call is parked and the parked slot number needed to unpark the call is displayed.
2. If you want to make a page announcement of the parked call, press **Page**. Otherwise, press **Exit**.
3. There are several methods by which you can select the user or hunt group that you want to page:
  - Select one of the pre-configured hunt groups and press **Page**.

## Parking Calls

- Press **Dir**. Select the required user or hunt group from the directory and press **Page**.
- Dial the extension number of the user or hunt group that you want to page and then press **Page**.

### Related links

[Parking Calls](#) on page 63

# Chapter 11: Conferencing

The telephone system supports multiple conference calls, with additional parties addable to any conference call until the system's conference capacity is reached. A maximum of 64 parties in any particular conference call is supported.

- If you are the only internal user in the conference, depending on your telephone system's configuration, dropping yourself might end the conference. Consult your system administrator for details.
- On J159 telephones, in addition to the **Conf** soft key, conference functions can be accessed using the  key.

## Related links

- [Starting a Conference](#) on page 67
- [Turning a Normal Call Into a Conference](#) on page 68
- [Adding Another Party Using Hold](#) on page 68
- [Adding Another Party Without Using Hold](#) on page 69
- [Viewing Conference Details](#) on page 69
- [Dropping/Muting Parties](#) on page 70
- [Holding a Conference Call](#) on page 70
- [Exiting a Conference](#) on page 70
- [Context Sensitive Conferencing](#) on page 71
- [Conference Short Codes](#) on page 72

---

## Starting a Conference

This is a simple method for creating a conference. For more complex scenarios, see [Context Sensitive Conferencing](#) on page 71.

### Procedure

1. If not already on a call, make a call to the first party or answer a call.
2. Press the **Conf** key. The current call is automatically put on hold.
3. Dial the party that you want to add to the conference.
  - If they answer and want to join the call, press **Conf** again. This call and your current held calls are turned into a conference call.

- If they do not want to join the call or do not answer, press **Drop**. Then press the appearance key of the previously held call to reconnect to that call.

**Related links**

[Conferencing](#) on page 67

---

## Turning a Normal Call Into a Conference

If your system administrator has configured a **Conference Add** button on your phone, you can press that button to turn your current call into a two-party conference. That then gives you access to the conference details features such as adding, muting and dropping conference parties without having had to put the existing call on hold.

Contact your system administrator for details of adding a **Conference Add** button.

**Related links**

[Conferencing](#) on page 67

---

## Adding Another Party Using Hold

This method of adding someone to a conference temporarily put your connection to the conference on hold. That allows you to hear the call progress and talk to the whoever answers the new call without the existing conference parties hearing that conversation.

The other parties already in the conference are able to continue talking to each other whilst you try to add the new party. You can also add a new party without using hold.

**Procedure**

1. Press **Conf** to put the conference on hold. This does not affect the other conference parties who can continue talking to each other.
2. Press an available appearance key on which to make a call.
3. Dial the party that you want to add to the conference.
  - If they answer and want to join the call, press **Conf** again. This call and your current held calls are turned into a conference call.
  - If they do not want to join the call or do not answer, press **Drop**. Then press the appearance key of the previously held call to reconnect to that call.

**Related links**

[Conferencing](#) on page 67

---

## Adding Another Party Without Using Hold

You can add another party to a conference without putting your connection to the conference on hold. This means that everyone in the conference hears the call progress and can immediately hear the other party when they answer.

You can also add a new party using hold if you do not want the existing conference to hear the process.

### Procedure

1. If not already highlighted, press the up or down cursor keys to display and highlight the conference call.
2. Press the **Details** soft key.
3. Press **Add**.
4. Enter the number of the party you want to add and press **Call**. Alternatively, press **Dir** to select a name from the directory.
5. If the other party does not answer, is not available or does not want to join the conference, press **Drop**.

### Related links

[Conferencing](#) on page 67

---

## Viewing Conference Details

You can display a list of the parties involved in a conference call.

### Procedure

1. If not already highlighted, press the up or down cursor keys to display and highlight the conference call.
2. Press the **Details** soft key.
3. You can perform various actions:
  - To scroll through the list of callers in the conference, use the up and down cursor keys.
  - To drop a caller from the conference, highlight them and press **Drop**. To leave the conference, drop yourself.
  - To mute a caller, highlight them and press **Mute**. Repeat this to unmute them.
  - To add another party to the conference without putting the conference on hold, press **Add**.
  - To return to the call display, press the **Back** soft key.

### Related links

[Conferencing](#) on page 67

---

## Dropping/Muting Parties

You can drop parties from a conference call, including yourself. You can also mute other parties.

- If you are the only internal user in the conference, depending on your telephone system's configuration, dropping yourself might end the conference. Consult your system administrator for details.

### Procedure

1. While connected to a conference call, if you press the **Details** key, the conference details menu is displayed.
2. You can then perform the following actions:

### Related links

[Conferencing](#) on page 67

---

## Holding a Conference Call

Using the **Hold** soft key you can put a conference call on hold in the same way as you can for a normal call. The appearance key for the conference call shows a fast-flashing red lamp.

To take the conference call off hold, press the appearance key.

### Important:

- You can hold a conference call in the same way as holding a normal call. Holding the conference call does not affect the other conference parties who can continue talking. You are still be listed as a member of the conference call in the conference details.
- This only applies to conference calls hosted by your own telephone system. Holding your call to a conference hosted on another telephone system may cause that conference to hear your system's music on hold.

### Related links

[Conferencing](#) on page 67

---

## Exiting a Conference

- If you are the only internal user in the conference, depending on your telephone system's configuration, dropping yourself might end the conference. Consult your system administrator for details.

## Procedure

1. If not already highlighted, press the up or down cursor keys to display and highlight the conference call.
2. Press the **Details** soft key.
3. Normally your own name is already selected by default. However, if not use the up or down cursor keys to select your own name.
4. Press **Drop**.

## Related links

[Conferencing](#) on page 67

---

# Context Sensitive Conferencing

The previous starting a conference method in this manual covers just simple scenarios where you want your current call and all held calls to be conferenced together. However, there may be some scenarios where you have multiple calls in progress where you may want to only conference particular calls.

This can be done by scrolling the display to change which call is highlighted when you press **Conf**. For example:

- **To conference the current call and a particular held call:** Scroll the call display to highlight the required held call. Press **Conf**. That held call is conferenced with your current call without affecting any other held calls.

The table below summarizes which calls are conferenced based on which call is currently highlighted on the telephone's display. A 'held pending transfer' call is one which has been put on hold by pressing **Conf** or **Transfer**.

The below only applies to conferences initiated from the telephone. The traditional behavior of conferencing the current and all held calls regardless of hold type still applies if the conference is initiated from elsewhere, for example an application.

Highligh ted Call	Other conditions in priority order	Result when Conf is pressed:	Current Call	Held Calls	Held Pending Transfer
<b>Connect ed Call</b>	No call held pending transfer	Conferences the connected call and all held calls.	✓	✓	–
	Call held pending transfer	Conferences the connected call and the held pending transfer call. Any other held calls are unaffected.	✓	–	✓

*Table continues...*

Highlighted Call	Other conditions in priority order	Result when Conf is pressed:	Current Call	Held Calls	Held Pending Transfer
<b>Held Call</b>	Connected call	Conferences the held call and the connected call. Any other held calls including held pending transfer are unaffected.	✓	–	–
	Held pending transfer call	Conferences the held and held pending transfer call. All other held calls are unaffected.	–	–	✓
	Held calls	Conferences with all other held calls.	–	✓	–
<b>Held Pending Transfer Call</b>	Connected call	Conferences the held pending transfer call to a connected call. Any other held calls are unaffected.	✓	–	✓
	Held calls	Conferences the call held pending transfer with all other held calls.	–	✓	✓

**To change which call is currently highlighted:**

1. Use the up and down cursor keys to select the current highlighted call appearance. This can be done without affecting any currently connected or held calls.
  - The currently highlighted button is shown by a white border around the button label.
  - The soft keys at the bottom of the display automatically change to reflect actions that can be performed on the call, if any, associated with the currently highlighted button.

**Related links**

[Conferencing](#) on page 67

## Conference Short Codes

Short codes are numbers that you can dial to enable and disable various features. The following are default short codes that may be available. However, your system administrator can remove and change the short codes available to you or all users. To use a short code, you may have to put your currently call on hold.

These are useful as they can be dialed from any phone on the system. For example, this allows you to login at a basic analog extension and still control a number of features.

Some short codes require you to enter some information when you dial them, typically an extension number. That is indicated by **N** in the short codes shown below.

- For a list of other common dialing short codes, see [Short Codes](#) on page 176.



## Conference

- **Conference Held Calls: \*47** – Start a conference between yourself and any calls that you have on hold.

### Related links

[Conferencing](#) on page 67

# Part 3: Redirecting Your Calls

## Call Redirection Options

The telephone system supports a number of different ways in which you can redirect your calls. The main methods are:

- **Follow Me** – Temporarily redirect all your calls to another phone shared with that phone's normal user. This function can be used in two ways:
  - **Follow Me To** – Set the follow me destination from your own phone.
  - **Follow Me Here** – Set the follow me destination from the phone that you want to use.
- **Forward** – Forward calls to an internal or external number.
  - **Forward on Busy** – Forward calls when you have reached the limit of the number of calls that the phone can present to you.
  - **Forward on No Answer** – Forward calls if they have rung unanswered at your phone.
  - **Forward Unconditional** – Immediately forward calls. Forwarding to voicemail can be selected as an option.
- **Do Not Disturb** – Redirect all calls to voicemail, if available. Otherwise, calls are redirected to a busy tone.
  - Do not disturb exception numbers can be used to allow calls from specific numbers to ignore do not disturb.
- **Twinning** – Twinning is a process whereby your calls ring on other phones than your own. Twinning is only available if configured by your system administrator. The system supports several twinning methods:
  - **Internal Twinning** – Ring on your extension and on another internal extension.
  - **Mobile Twinning** – Ring on your extension and an external number.
  - **Fallback Twinning** – Ring on an external number when the system cannot detect a connection to your normal phone.

Method		Calls Redirected			Destination		
		Internal	External	Group	Internal	External	Voicemail
Follow Me	Follow Me To	✓	✓	✓	✓	–	–
	Follow Me Here	✓	✓	✓	✓	–	–
Forward	Forward on Busy	✓	✓	–	✓	✓	–
	Forward on No Answer	✓	✓	–	✓	✓	–
	Forward Unconditional	✓	✓	✓	✓	✓	✓
Do Not Disturb		✓	✓	–	–	–	✓
Twinning	Internal	✓	✓	✓[1]	✓	✓	✓
	Mobile	✓	✓	✓[1]	–	✓	–
	Fallback	✓	✓	✓[1]	–	✓	–

1. Configured by your system administrator.

# Chapter 12: Forwarding Calls

Forwarding is used to redirect calls to another extension or an external number.

## Forward Unconditional

Forward unconditional can be used to immediately redirect your calls.

- By default this function is only applied to incoming external calls to you. However, if required internal calls and or hunt group calls can also be selected.
- When enabled, all calls matching the settings are forwarded to the number set as your forward unconditional destination. That number can be internal or external.
- You can still use the phone to make outgoing calls. When you go off-hook you hear interrupted dial tone.
- If you also have forward on no answer set, if the unconditionally forwarded call is still unanswered after having rung for your no answer time (default 15 seconds), the system redirects the call to your forward on no answer destination if different. Note that this is not always possible for calls that have been forwarded to an external number.
- If you also have voicemail enabled , if the forwarded call is still unanswered, the system redirects the call to voicemail. Note, this is not always possible for calls that have been forwarded to an external number.
-  **Forward Unconditional** – This icon indicates that you have forward unconditional enabled.

## Forward on Busy

'Forward on busy' redirects your calls when your phone is not able to present you with any more alerting calls.

- By default, this function is only applied to incoming external calls made to you. However, if required, internal calls can also be selected.
- When enabled, all calls matching the settings are forwarded to the number set as the 'forward on busy'/'no answer' destination. That number can be internal or external.
- 'Busy' is defined as having no available call appearance buttons on which further calls can be presented.
- Hunt group calls are not presented when you are busy and so are not forwarded by this setting.
- The 'forward on busy' and 'forward on no answer' options use the same forwarding destination number. If no number is set, they use the same destination as set for 'forward unconditional.'
- If you also have voicemail enabled , if the forwarded call is still unanswered, the system redirects the call to voicemail. Note, this is not always possible for calls that have been forwarded to an external number.

## Forward on No Answer

Forward on no answer redirect calls that have alerted your phone but have not been answered for some reason.

- By default this function is only applied to incoming external calls to you. However if required internal calls can also be selected.
- When enabled, all calls matching the settings are forwarded to the number set as the forward on busy/no answer destination. That number can be internal or external.
- No answer is defined as having been presented to your phone for your no answer time (default 15 seconds).
- Hunt group calls are not forwarded.
- The 'forward on busy' and 'forward on no answer' options use the same forwarding destination number. If no number is set, they use the same destination as set for 'forward unconditional.'
- If you also have voicemail enabled, if the forwarded call is still unanswered, the system redirects the call to voicemail. Note, this is not always possible for calls that have been forwarded to an external number.

### Related links

- [Forward Unconditional \(Status Menu\)](#) on page 77
- [Forward Unconditional \(Features Menu\)](#) on page 78
- [Forward on Busy/No Answer \(Features Menu\)](#) on page 78
- [Forward on No Answer \(Status Menu\)](#) on page 79
- [Forward on Busy \(Status Menu\)](#) on page 80
- [Call Forwarding Short Codes](#) on page 80

---

## Forward Unconditional (*Status Menu*)

You can clear or change your 'forward unconditional' settings through the **Status** menu.

### Procedure

1. Press the **Status** soft key if shown.
  - To do this during a call, press the  **PHONE** key and then press the **Status** soft key.
2. Use the cursor keys to select **Forward Unconditional**.
  - To switch off forward unconditional, press the **Off** soft key.
  - To change the forwarding settings, press the **Details** soft key.
3. Press **Save**.

### Related links

- [Forwarding Calls](#) on page 76

---

## Forward Unconditional (*Features Menu*)

You may be able to change your 'forward unconditional' settings using the Features menu.

- Your system administrator can configure whether you can access this menu.

### Procedure

1. Press the **Features** soft key if shown.
  - To do this during a call, press the  **PHONE** key and then press **Features**.
2. Use the cursor keys to select **Forward**.
3. Use the cursor keys to select **Forward Unconditional**.
  - **To Switch On/Off** – Select **Forward Unconditional**. Press **On** or **Off** to change the current setting. If no destination is currently set when you switch 'forward unconditional' on, the display jumps to the destination field.
  - **To Select Which Calls as Forwarded** – Select **Call type**. Press **Change** to see the different options. When the required option is displayed, press **Save**. The options are **External Only**, **External and Group**, **Non Group Calls** and **All Calls**.
  - **To Set the Destination** – Select **Destination**. Either press **Edit** and enter the number required or press **ToVM** for the 'forward to voicemail' option.
    - If you select voicemail as the destination, to enter a different destination, you first need to switch 'forward unconditional' off.
4. Press **Save**.

### Related links

[Forwarding Calls](#) on page 76

---

## Forward on Busy/No Answer (*Features Menu*)

You may be able to use the **Features** menu to switch 'forward on no answer' and 'forward on busy' on or off.

- Your system administrator can configure whether you can access this menu.

### Procedure

1. Press the **Features** soft key if shown.
  - To do this during a call, press the  **PHONE** key and then press **Features**.
2. Use the cursor keys to select **Forward**.
3. Use the cursor keys to select **Forward Busy/No Answer**.

4. Use the cursor keys to scroll through the menu options:
  - To switch 'forward on busy' on or off, highlight **Fwd Busy** and press **On** or **Off**.
  - To switch 'forward on no answer' on or off, highlight **Fwd No Answer** and press **On** or **Off**.
  - To select which calls are forwarded, highlight **Call type**. Press **Change** to change the option between **All Calls** or **External Only**.
  - To change the destination, highlight **Destination** and press **Edit**. Enter the number and press **Select**.
  - Press **Save** to save any changes.

#### Related links

[Forwarding Calls](#) on page 76

---

## Forward on No Answer (*Status Menu*)

If your phone is set to 'forward on no answer' you can clear or change the forward settings through the **Status** menu.

- Your system administrator can configure whether you can access this menu.

#### Procedure

1. Press the **Status** soft key if shown.
  - To do this during a call, press the  **PHONE** key and then press the **Status** soft key.
2. Use the cursor keys to select **Forward on No Answer**.
3. To switch forwarding off, press **Off**.
4. To change the setting, press **Details**.
  - To switch 'forward on busy' on or off, highlight **Fwd Busy** and press **On** or **Off**.
  - To switch 'forward on no answer' on or off, highlight **Fwd No Answer** and press **On** or **Off**.
  - To select which calls are forwarded, highlight **Call type**. Press **Change** to change the option between **All Calls** or **External Only**.
  - To change the destination, highlight **Destination** and press **Edit**. Enter the number and press **Select**.
  - Press **Save** to save any changes.

#### Related links

[Forwarding Calls](#) on page 76

---

## Forward on Busy (*Status Menu*)

If your phone is set to 'forward on busy' you can clear or change the forward settings through the **Status** menu.

- Your system administrator can configure whether you can access this menu.

### Procedure

1. Press the **Status** soft key if shown.
  - To do this during a call, press the  **PHONE** key and then press the **Status** soft key.
2. Use the cursor keys to select **Forward on No Answer**.
3. To switch forwarding off, press **Off**.
4. To change the setting, press **Details**.
  - To switch 'forward on busy' on or off, highlight **Fwd Busy** and press **On** or **Off**.
  - To switch 'forward on no answer' on or off, highlight **Fwd No Answer** and press **On** or **Off**.
  - To select which calls are forwarded, highlight **Call type**. Press **Change** to change the option between **All Calls** or **External Only**.
  - To change the destination, highlight **Destination** and press **Edit**. Enter the number and press **Select**.
  - Press **Save** to save any changes.

### Related links

[Forwarding Calls](#) on page 76

---

## Call Forwarding Short Codes

Short codes are numbers that you can dial to enable and disable various features. The following are default short codes that may be available. However, your system administrator can remove and change the short codes available to you or all users. To use a short code, you may have to put your currently call on hold.

These are useful as they can be dialed from any phone on the system. For example, this allows you to login at a basic analog extension and still control a number of features.

Some short codes require you to enter some information when you dial them, typically an extension number. That is indicated by **N** in the short codes shown below.

- For a list of other common dialing short codes, see [Short Codes](#) on page 176.



## Forwarding

- **Forward Unconditional:**
  - **Set the Forward Unconditional Destination: \*07\*N#** – Set the destination number (*N*) for 'forward unconditional' when it is switched on.
  - **Switch Forward Unconditional On: \*01** – Switch on 'forward unconditional.' A destination must have been set.
  - **Switch Forward Unconditional Off: \*02**
  - **Include Hunt Group Calls in Forward Unconditional: \*50**
  - **Exclude Hunt Group Calls from Forward Unconditional: \*51**
- **Forward on Busy/No Answer:**
  - **Set the Forward On Busy/No Answer Destination: \*57\*N#** – Set the destination number (*N*) for 'forward on busy' and 'forward on no answer.' If no number has been set, those functions use the 'forward unconditional' number if set.
  - **Switch Forward On Busy On: \*03**
  - **Switch Forward On Busy Off: \*04**
  - **Switch Forward on No Answer On: \*05**
  - **Switch Forward on No Answer Off: \*06**
- **Cancel All Forwarding: \*00** – Switch off any forwarding (includes 'forward unconditional,' 'forward on busy,' 'forward on no answer,' 'follow me,' and 'do not disturb').

### Related links

[Forwarding Calls](#) on page 76

# Chapter 13: Do Not Disturb

When you enable 'do not disturb':

- Calls to you are redirected to voicemail if available. Otherwise, the callers hear busy tone.
- People calling from numbers in your 'do not disturb' exceptions list can still call you and forwarding can still be applied to these calls.
- Calls to any hunt group of which you are a member are no longer presented to you (unless you are the last available member of the group).
- Call already alerting your phone are not affected and continue alerting.
- You can still use the phone to make outgoing calls. When you go off-hook you hear interrupted dial tone.
-  **Do Not Disturb** – This icon indicates that you have do not disturb enabled.

## Related links

[DND On/Off \(Features Menu\)](#) on page 82

[DND Off \(Status Menu\)](#) on page 83

[Do Not Disturb Exceptions](#) on page 83

[Do Not Disturb Short Codes](#) on page 84

---

## DND On/Off (*Features Menu*)

Enabling DND does not affect any calls already being presented to your phone.

### Procedure

1. Press the **Features** soft key if shown.
  - To do this during a call, press the  **PHONE** key and then press **Features**.
2. Use cursor keys to select **Call Settings**.
3. Use the cursor keys to select **Do Not Disturb**.
4. Press the **Change** button to select **On** or **Off**.
5. Press **Save**.

## Related links

[Do Not Disturb](#) on page 82

---

## DND Off (*Status Menu*)

You can use the **Status** menu to switch off 'do not disturb.'

- Your system administrator can configure whether you can access this menu.

### Procedure

1. Press the **Status** soft key if shown.
  - To do this during a call, press the  **PHONE** key and then press the **Status** soft key.
2. Use the cursor keys to select **Do Not Disturb**.
3. To clear the 'do not disturb' setting, press the **Off** soft key.

### Related links

[Do Not Disturb](#) on page 82

---

## Do Not Disturb Exceptions

These numbers are used to indicate callers who you want to be allowed to call you as normal even when you have 'do not disturb' on. This does not include group calls which are not presented when you are in 'do not disturb'.

- Your system administrator can configure whether you can access this menu.
- This menu is not supported on the J139.

### Procedure

1. Press the **Features** soft key if shown.
  - To do this during a call, press the  **PHONE** key and then press **Features**.
2. Use cursor keys to select **Call Settings**.
3. Use the cursor keys to select **DND Exceptions**.
  - To add a number, highlight **Add Another**. Dial the number and press **Add**.
    - If your system uses an external dialing prefix to make outgoing calls, add the prefix when adding an external number as an exception.
  - To remove an existing number, highlight it and press **Remove**.
4. Press **Done** when completed.

### Related links

[Do Not Disturb](#) on page 82

---

## Do Not Disturb Short Codes

Short codes are numbers that you can dial to enable and disable various features. The following are default short codes that may be available. However, your system administrator can remove and change the short codes available to you or all users. To use a short code, you may have to put your currently call on hold.

These are useful as they can be dialed from any phone on the system. For example, this allows you to login at a basic analog extension and still control a number of features.

Some short codes require you to enter some information when you dial them, typically an extension number. That is indicated by **N** in the short codes shown below.

- For a list of other common dialing short codes, see [Short Codes](#) on page 176.

### Do Not Disturb

- **Switch Do Not Disturb On: \*08** – Set your phone to 'do not disturb.'
- **Switch Do Not Disturb Off: \*09** – Switch off 'do not disturb.'
- **Add a Do Not Disturb Exception Number: \*10\*N#** – Add a number (**N**) to your list of 'do not disturb' exceptions.
- **Delete a Do Not Disturb Exception Number: \*11\*N#** – Remove a number (**N**) from your list of 'do not disturb' exceptions.
- **Cancel All Forwarding: \*00** – Switch off any forwarding (includes 'forward unconditional,' 'forward on busy,' 'forward on no answer,' 'follow me,' and 'do not disturb').

### Related links

[Do Not Disturb](#) on page 82

# Chapter 14: Follow Me

'Follow me to' is used to redirect your calls to another extension that you are temporarily sharing.

The calls are presented with your user name so that they can be distinguished from calls for the extension's normal user. This allows you to share another person's phone without logging them off their phone.

All calls are redirected and the calls are still subject to all your user settings as if they were ringing at your phone.

- **'Follow me to'** is used to enable 'follow me' from your own phone.
- **'Follow me here'** is used to enable 'follow me' at the extension to which you want your calls redirected.

## Related links

[Follow Me To \(Features Menu\)](#) on page 85

[Follow Me \(Status Menu\)](#) on page 86

[Follow Me Here \(Features Menu\)](#) on page 86

[Follow Me Here \(Status Menu\)](#) on page 87

[Follow Me Short Codes](#) on page 87

---

## Follow Me To (*Features Menu*)

Using the phone's **Features** menu, you can set and clear follow me to settings.

- Your system administrator can configure whether you can access this menu.

### Procedure

1. Press the **Features** soft key if shown.
  - To do this during a call, press the  **PHONE** key and then press **Features**.
2. Use the cursor keys to select **Forward**.
3. Use the cursor keys to select **Follow Me To**.
4. Dial the number of another user. When it matches a user, their name is displayed. Alternatively, use the **Dir** soft key to select a user from the directory.

5. Select an action:

- **Save** – Save the selected number as your 'follow me to' destination. All calls to your extension number are redirected to that destination.
- **Clear** – Clear the currently selected or set number.
- **Back** – Go back to the previous menu.

**Related links**

[Follow Me](#) on page 85

---

## Follow Me (*Status Menu*)

If you have set a 'follow me to' destination for your calls, you can clear or change the setting through your phone's **Status** menu.

**Procedure**

1. Press the **Status** soft key if shown.
  - To do this during a call, press the  **PHONE** key and then press the **Status** soft key.
2. Use the up and down cursor keys to highlight **Follow Me To**.
  - To clear the 'follow me to' setting, press the **Clear** soft key.
  - To change the destination of the setting, press the **Details** soft key.

**Related links**

[Follow Me](#) on page 85

---

## Follow Me Here (*Features Menu*)

You may be able to change 'follow me here' using the **Features** menu.

- Your system administrator can configure whether you can access this menu.

**Procedure**

1. Press the **Features** soft key if shown.
  - To do this during a call, press the  **PHONE** key and then press **Features**.
2. Use the cursor keys to select **Forward**.
3. Use the cursor keys to select **Follow Me Here**.
4. Use the menu to add or remove users:
  - Use the up and down cursor keys to scroll through the names.

- To remove a user, press the **Clear** soft key.
  - To add a user, press the **Add** soft key.
    - Dial the number of another user. When it matches a user, their name is displayed. Alternatively, use the **Dir** soft key to select a user from the directory.
    - Press the **Save** soft key to add them.
5. Press **Save**.

**Related links**

[Follow Me](#) on page 85

---

## Follow Me Here (*Status Menu*)

If other users has a 'follow me' set to your phone, you can clear or change the setting through the **Status** menu.

**Procedure**

1. Press the **Status** soft key if shown.
  - To do this during a call, press the  **PHONE** key and then press the **Status** soft key.
2. Use the up and down cursor keys to highlight **Follow Me Here**.
  - To clear the setting, press the **Clear** soft key.
  - To change the destination of the setting, press the **Details** soft key.

**Related links**

[Follow Me](#) on page 85

---

## Follow Me Short Codes

Short codes are numbers that you can dial to enable and disable various features. The following are default short codes that may be available. However, your system administrator can remove and change the short codes available to you or all users. To use a short code, you may have to put your currently call on hold.

These are useful as they can be dialed from any phone on the system. For example, this allows you to login at a basic analog extension and still control a number of features.

Some short codes require you to enter some information when you dial them, typically an extension number. That is indicated by **N** in the short codes shown below.

- For a list of other common dialing short codes, see [Short Codes](#) on page 176.

## Follow Me

- **Follow Me Here: \*12\*N#** – Dialed at the extension to which you want your calls redirected. Use your own extension number (**N**) when dialing the short code.
- **Follow Me Here Cancel: \*13\*N#** – Dialed at the extension from which you had redirected calls. Use your own extension number (**N**) when dialing the short code.
- **Follow Me To: \*14\*N#** – Dialed at your phone. Dial the extension number (**N**) to which you want your calls redirected. You can dial just **\*14#** to cancel follow me.
- **Cancel All Forwarding: \*00** – Switch off any forwarding (includes 'forward unconditional,' 'forward on busy,' 'forward on no answer,' 'follow me,' and 'do not disturb').

## Related links

[Follow Me](#) on page 85



# Chapter 15: Twinning

Twining is a process whereby your calls ring on two phones. Twinning is only available if configured by your system administrator. The system supports several methods of twinning.

Feature	Description
<b>Mobile Twinning</b>	<p>Mobile twinning allows your calls to ring at both your phone's and at another phone's number, which can include an external number. If you have been configured as a mobile twinning user, you can switch the use of mobile twinning on or off through the phone's menus and can also change the number to which you are twinned.</p> <p>Using the phone menus, you can switch use of mobile twinning on/off and change the destination number for twinned calls.</p>
<b>Fallback Twinning</b>	<p>When enabled, this feature redirected your calls to your mobile twinning number when the system is unable to detect your normal extension connected to the system. You can use fallback twinning without having to have mobile twinning switched on.</p>
<b>Internal Twinning</b>	<p>This method of twinning twins your normal phone with another internal phone. Your incoming calls ring on both phones. You can also make your calls from either extension.</p> <ul style="list-style-type: none"><li>• A typical example for internal twinning would be a user who uses both a normal desk phone and also needs a mobile phone while moving around the building.</li><li>• Your settings are applied to both phones. Similarly, message waiting indication and voicemail access from either phone is to your mailbox.</li><li>• If both phones are phones that store your contacts and call history on the system, the contacts and call history on each is the same.</li></ul>

## Related links

[Switching Mobile Twinning On](#) on page 90

[Changing Your Twinning Number](#) on page 90

[Transferring a Call to Your Mobile](#) on page 91

[Reclaiming a Twinned Call](#) on page 91

[Switching Mobile Twinning Off](#) on page 91

[Switching Fallback Twinning On](#) on page 92

[Switching Fallback Twinning Off](#) on page 92

---

## Switching Mobile Twinning On

The twinning menu is only available if you have been configured by the system administrator to be able to use mobile twinning.

- Setting a button to the **Twinning** function is recommended. The button allows you to transfer calls to your twinning destination, reclaim twinned calls, and quickly access the twinning menu.

### Procedure

1. Press the **Features** soft key if shown.
  - To do this during a call, press the  **PHONE** key and then press **Features**.
2. Use the cursor keys to select **Forward**.
3. Use the cursor keys to select **Mobile Twinning**.
4. If no twinning number has been set yet, select **Destination** and click **Edit**. Enter the number required and press **Select**.
5. Select **Twinning**. Press **On**.
6. Press **Save**.

### Related links

[Twinning](#) on page 89

---

## Changing Your Twinning Number

The mobile twinning number is used for both mobile and fallback twinning. It is not used for internal twinning. See [Twinning](#) on page 89.

It should be an external number. If your system users an external dialing prefix you should include that in the number you set.

### Procedure

1. Press the **Features** soft key if shown.
  - To do this during a call, press the  **PHONE** key and then press **Features**.
2. Use the cursor keys to select **Forward**.
3. Use the cursor keys to select **Mobile Twinning**.
4. Highlight **Destination** and press **Edit**.
  - Use the **Bksp** to remove the last digit of the existing number.
  - Use **Clear** to remove the whole number.
  - Dial the number you want to use for twinning and press **Select**.

5. Press **Save**.

**Related links**

[Twinning](#) on page 89

---

## Transferring a Call to Your Mobile

If you have been configured as a mobile twinning user, you can transfer a call to your mobile device using the features menu.

- Your system administrator can configure whether you can access this menu.

**Procedure**

1. Press the **Features** soft key if shown.
  - To do this during a call, press the  **PHONE** key and then press **Features**.
2. Use the cursor keys to select **Transfer to Mobile**.

**Related links**

[Twinning](#) on page 89

---

## Reclaiming a Twinned Call

When using mobile twinning, you can use the status menu to take back a call that has been redirected to and answered at your mobile twinning destination.

**Procedure**

1. Press the **Status** soft key if shown.
  - To do this during a call, press the  **PHONE** key and then press the **Status** soft key.
2. Use the cursor keys to select **Mobile Twin Call**.
3. Press **Connect**.

**Related links**

[Twinning](#) on page 89

---

## Switching Mobile Twinning Off

If you have been configured as a mobile twinning user, you can use the status menu to switch mobile twinning mode off.

### Procedure

1. Press the **Status** soft key if shown.
  - To do this during a call, press the  **PHONE** key and then press the **Status** soft key.
2. Use the up and down cursor keys to highlight **Mobile Twining**.
  - To clear the setting, press the **Off** soft key.
  - To access the twining menu instead, press **Details**.

### Related links

[Twining](#) on page 89

---

## Switching Fallback Twining On

When enabled, this feature redirected your calls to your mobile twining number when the system is unable to detect your normal extension connected to the system. You can use fallback twining without having to have mobile twining switched on.

### Procedure

1. Press the **Features** soft key if shown.
  - To do this during a call, press the  **PHONE** key and then press **Features**.
2. Use the cursor keys to select **Forward**.
3. Use the cursor keys to select **Mobile Twining**.
4. If no twining number has been set yet, select **Destination** and click **Edit**. Enter the number required and press **Select**.
5. Select **Fallback Twining**. Press **On**.
6. Press **Save**.

### Related links

[Twining](#) on page 89

---

## Switching Fallback Twining Off

Fallback twining is used when the system cannot detect the normal connection to your phone. The twining menu is only available if you have been configured by the system administrator to be able to use mobile twining.

## Procedure

1. Press the **Features** soft key if shown.
  - To do this during a call, press the  **PHONE** key and then press **Features**.
2. Use the cursor keys to select **Forward**.
3. Use the cursor keys to select **Mobile Twinning**.
4. If no twinning number has been set yet, select **Destination** and click **Edit**. Enter the number required and press **Select**.
5. Select **Fallback Twinning**. Press **Off**.
6. Press **Save**.

## Related links

[Twining](#) on page 89

# Part 4: Contacts and Call Log

# Chapter 16: Contacts

This menu is accessed by pressing the **CONTACTS** key. It is used to display names and numbers that you can then use for making calls.

The directory includes names stored for use by all users, names stored for use by just you and the name and numbers of all the other users and groups on the phone system.

The contacts shown in the directory come from a number of sources.

Source/Type	Description
<b>Personal</b>	<p>These contacts are stored by the telephone system as part of your user settings.</p> <ul style="list-style-type: none"><li>• They are displayed on the phone while you are using it. If you hot desk to another phone that also stores your contacts on the system, your personal contacts move with you.</li><li>• You can have up to 250 personal directory entries that you can add, edit and delete through the phone.<ul style="list-style-type: none"><li>- <b>Note:</b> While you are allowed up to 250 personal directory entries, the total capacity of the system may limit that if it has been reached.</li></ul></li><li>• The system administrator can add, edit and delete your personal directory entries.</li><li>• The system administrator can apply an exclude from directory setting to particular users and hunt groups. They are then not included in the directory seen by other users.</li></ul>
<b>Users</b>	<p>These contacts list all the other users on the telephone system. If your system is part of a network of telephone systems, it includes users on the other systems.</p>
<b>Groups</b>	<p>These contacts list all the hunt groups on the telephone system. If your system is part of a network of telephone systems, it includes those hunt groups that the system administrator has configured to be advertised across the network.</p>
<b>External</b>	<p>These contacts are viewable and usable by all phone users. These are two types of external contacts:</p> <ul style="list-style-type: none"><li>• Some external contacts are entered into the telephone system configuration by the system administrator.</li><li>• Other external contacts are those imported by the telephone system from other directory sources.</li></ul>

## Related links

- [How the Directory Search Works](#) on page 96
- [Managing External Contacts](#) on page 99
- [Viewing Contacts](#) on page 99
- [Making a Call from the Directory](#) on page 100
- [Using the Directory for Other Functions](#) on page 101
- [Adding a New Contact](#) on page 101
- [Adding a Contact from Your Call Log](#) on page 102
- [Editing a Contact](#) on page 103
- [Deleting a Contact](#) on page 103

---

## How the Directory Search Works

The phone's directory search works by applying a progressive match as you dial additional keys. That matching is applied simultaneously to all parts of the names.

- Starting by pressing **4** (the **GHI** key), matches all names where part of the name begins with a **G, H** or **I**.
  - Then pressing **3** (the **DEF** key) reduces the matches shown to those where part of the name begins with **Gd, Ge, Gf, Hd, He** and so on.
- As you dial, the possible matches shown on the display reduce.
- At any time, you can scroll the list of matches and select one of the matches or press another dialpad key to improve the matching further.

For example, to search for "*Henry Jones*", you can dial **HENRY** by pressing 43679.



Dial	H	E	N	R	Y
Matches	4GHI	3DEF	6MNO	7PQRS	9WXYZ
Adam Johns	Claire <b>G</b> reggs	<b>G</b> emma Jones	<b>G</b> emma Jones	<b>H</b> enrietta Green	<b>H</b> enry Jones
Bob Smith	<b>G</b> emma Jones	<b>H</b> enrietta Green	<b>H</b> enrietta Green	<b>H</b> enry Jones	<b>H</b> enry Smith
Claire Greggs	<b>H</b> arold Bishop	<b>H</b> enry Jones	<b>H</b> enry Jones	<b>H</b> enry Smith	
Gemma Jones	<b>H</b> enrietta <b>G</b> reen	<b>H</b> enry Smith	<b>H</b> enry Smith	Tony <b>G</b> eorge	
Harold Bishop	<b>H</b> enry Jones	<b>I</b> da James	Tony <b>G</b> eorge	Simon <b>H</b> enricks	
Henrietta Green	<b>H</b> enry Smith	IT <b>H</b> elpdesk	Simon <b>H</b> enricks		
Henry Jones	<b>I</b> da James	Tony <b>G</b> eorge			
Henry Smith	IT <b>H</b> elpdesk	Simon <b>H</b> enricks			
Ida James	Tony <b>G</b> eorge	Sales <b>H</b> elp			
IT Helpdesk	Simon <b>H</b> enricks				
London Office	Sales <b>H</b> elp				
John Smith					
Tony George					
Simon Henricks					
Sales Support					
Sales Help					

Alternatively to search for "Henry Jones", you could dial **JONES** by pressing 56637.

Dial	J	O	N	E	S
Matches	5JKL	6MNO	6MNO	3DEF	7PQRS
Adam Johns	Adam <u>J</u> ohns	Adams <u>J</u> ohns	Gemma <u>J</u> ones	Gemma <u>J</u> ones	Gemma <u>J</u> ones
Bob Smith	Gemma <u>J</u> ones	Gemma <u>J</u> ones	Henry <u>J</u> ones	Henry <u>J</u> ones	Henry <u>J</u> ones
Claire Greggs	Henry <u>J</u> ones	Henry <u>J</u> ones	<u>L</u> ondon Office	<u>L</u> ondon Office	
Gemma Jones	Ida <u>J</u> ames	<u>J</u> ohn Smith			
Harold Bishop	<u>J</u> ohn Smith	<u>L</u> ondon Office			
Henrietta Green	<u>L</u> ondon Office	Peter <u>J</u> ohnson			
Henry Jones	Peter <u>J</u> ohnson				
Henry Smith					
Ida James					
IT Helpdesk					
John Smith					
London Office					
Peter Johnson					
Tony George					
Simon Henricks					
Sales Support					
Sales Help					

### Dialing Additional and Accented Characters

The keys on the telephone number pad can be used to enter characters other than those marked on the button.

For example, though marked with just **ABC**, the 2 key also matches the accented forms of those characters, for example **À, Á, Â, Ã, Ä, Å** and **Ç**. The set of additional unmarked characters matched varies depending on the language settings of your system.

### Alternate Search Methods

By default, the name matching is applied simultaneously all parts of the contact names, ie. the first, middle and last parts of the displayed names. Your system administrator can change this to a more basic search if required; for example to match from just the start of the first name or last name. However, the change applies to all phones on the system.

### Related links

[Contacts](#) on page 95

---

## Managing External Contacts

If you have been configured as a system phone user by the system administrator, then you can also add, edit and delete some external directory contacts.

- This only applies to external directory contacts entered locally into configuration of the telephone system to which you are logged in.
- External directory contacts imported by the system from other sources cannot be edited. However, if a local entry is created with the same name or number as an imported entry, the imported entry is discarded in favor of the local one.

### Related links

[Contacts](#) on page 95

---

## Viewing Contacts

### Procedure

1. Access the directory contacts:
  - a. Press the **CONTACTS** key. The directory menu is displayed.
  - b. Use the left and right cursor keys to select the type of directory entries shown.
    - **All** - All directory entries.
    - **Personal** - Your own personal directory entries.
    - **External** - Directory entries stored by the telephone system for all users to use.
    - **Users** - The names and numbers of other users on the telephone system.
    - **Groups** - The names and numbers of hunt groups on the telephone system.
  - a. Use the up and down cursor keys to scroll through the list. Alternatively, you can start dialing the name you want to display only matching entries as follows:
    - Pressing a key enters all of the characters represented by that key. Pressing another key adds the characters from that button to the previous key press.
    - For example, dialing **527** matches all names starting with **JAS** (for example "Jason") and with **KAR** (for example "Karl") plus any other letter combinations from those 3 key presses. See [How the Directory Search Works](#) on page 96.
    - To remove all the characters entered so far, press **Clear**.
  - b. To view more details of the highlighted name, press **Details**. To return to the directory press **List**.
2. When the required entry is highlighted, press **Details** to display the name, number and type of contact.
3. Use the up and down cursor keys to scroll through the contacts.

4. The soft keys available depends on the type of directory entry:
  - **Call** - Make a call to the stored number.
  - **List** - Return to the list of contacts.
  - **More** - If the contact is one you can edit, the **More** soft key allows you to access the options below.
  - **Edit** - Edit the name and number.
  - **Delete** - Delete the name and number.
  - **New** - Add a new personal directory contact.

#### Related links

[Contacts](#) on page 95

---

## Making a Call from the Directory

You can use any directory contact to make a call.

- You can also use the directory to select a contact anytime the **Dir** soft key is displayed in the function's menus. In that case, the system automatically only shows the types of contacts supported for the function.

#### Procedure

1. Access the contacts directory:
  - a. Press the **CONTACTS** key. The directory menu is displayed.
  - b. Use the left and right cursor keys to select the type of directory entries shown.
    - **All** - All directory entries.
    - **Personal** - Your own personal directory entries.
    - **External** - Directory entries stored by the telephone system for all users to use.
    - **Users** - The names and numbers of other users on the telephone system.
    - **Groups** - The names and numbers of hunt groups on the telephone system.
  - a. Use the up and down cursor keys to scroll through the list. Alternatively, you can start dialing the name you want to display only matching entries as follows:
    - Pressing a key enters all of the characters represented by that key. Pressing another key adds the characters from that button to the previous key press.
    - For example, dialing **527** matches all names starting with **JAS** (for example "Jason") and with **KAR** (for example "Karl") plus any other letter combinations from those 3 key presses. See [How the Directory Search Works](#) on page 96.
    - To remove all the characters entered so far, press **Clear**.

- b. To view more details of the highlighted name, press **Details**. To return to the directory press **List**.
2. When the required entry is highlighted, press **Call** or press the  button next to the name.
3. Proceed as you would with a normally dialed call.

**Related links**

[Contacts](#) on page 95

---

## Using the Directory for Other Functions

Within other menus where entry of a number is required, it may be possible to use the directory to select an existing number by name. If this option is available, it is indicated by the **Dir** soft key appearing.

When using the directory in this way, the contacts shown depend on the type of function being set. For example, for some functions only group names are displayed, for others only user names.

**Procedure**

1. Press the **Dir** soft key.
2. Either dial the name to see a list of matches or press the **List** soft key to list all names.
  - a. Use the up and down cursor keys to scroll through the list. Alternately start dialing the name you want to find to display only matching entries. If you dial a name, to return to the full list press the **Clear** soft key.
  - b. To view more details of the highlighted name press **Details**. To return to the directory press **List**.
3. When the required entry is highlighted, press **Select**.
4. You are returned to the menu in which you selected the **Dir** soft key.

**Related links**

[Contacts](#) on page 95

---

## Adding a New Contact

So long as the telephone system capacity has not been reached, you can add up to 250 personal directory entries.

- If you have been configured as a system phone user by the system administrator, then you can also add, edit and delete some external directory contacts.

## Procedure

1. Access your personal directory contacts:
  - a. Press the **CONTACTS** key. The directory menu is displayed.
  - b. Use the left and right cursor keys to select your **Personal** directory.
2. Press the **New** soft key.
  - a. The menu now allows editing of the name and number. See [Entering Text Characters](#) on page 198.
  - b. Use the up and down cursor keys to switch between number and name entry.
  - c. When the name and number have been entered as required, press the **Save** soft key.
  - d. To exit without making any changes, press the **Cancel** soft key.

## Related links





[Contacts](#) on page 95

---

# Adding a Contact from Your Call Log

You can add a name and number shown in your call log to your personal contacts.

## Procedure

1. Access your call log:
  - a. Press the  **CALL LOG** button.
    - If you have any new missed calls, the button is illuminated and opening the call log shows missed calls.
  - b. Use the left/right cursor keys to select the type of records shown: **All**,  **Outgoing**,  **Incoming** and  **Missed**.
  - c. Use the up/down cursor keys to scroll through the records.
2. Press **More** and then press the **+Contact** soft key.
3. Use the up and down cursor keys to switch between the name and number details for the new contact.
4. Using the telephone keypad and the **Bksp** soft key you can edit the name and the number. See [Entering Text Characters](#) on page 198.
5. When the name and number are set as required, press the **Save** soft key. To return without saving the name and number, press the **Cancel** soft key.

## Related links

[Contacts](#) on page 95

---

## Editing a Contact

You can edit the contacts in your own personal directory.

- If you have been configured as a system phone user by the system administrator, then you can also add, edit and delete some external directory contacts.

### Procedure

1. Access your personal directory contacts:
  - a. Press the **CONTACTS** key. The directory menu is displayed.
  - b. Use the left and right cursor keys to select your **Personal** directory.
  - a. Use the up and down cursor keys to scroll through the list. Alternatively, you can start dialing the name you want to display only matching entries as follows:
    - Pressing a key enters all of the characters represented by that key. Pressing another key adds the characters from that button to the previous key press.
    - For example, dialing **527** matches all names starting with **JAS** (for example "Jason") and with **KAR** (for example "Karl") plus any other letter combinations from those 3 key presses. See [How the Directory Search Works](#) on page 96.
    - To remove all the characters entered so far, press **Clear**.
  - b. To view more details of the highlighted name, press **Details**. To return to the directory press **List**.
2. Locate the required entry and press **Details**.
3. Press **More** and then **Edit**.
  - a. The menu now allows editing of the name and number. See [Entering Text Characters](#) on page 198.
  - b. Use the up and down cursor keys to switch between number and name entry.
  - c. When the name and number have been entered as required, press the **Save** soft key.
  - d. To exit without making any changes, press the **Cancel** soft key.

### Related links

[Contacts](#) on page 95

---

## Deleting a Contact

You can delete a contact from your own personal directory.

- If you have been configured as a system phone user by the system administrator, then you can also add, edit and delete some external directory contacts.

## Procedure

1. Access your personal directory contacts:
  - a. Press the **CONTACTS** key. The directory menu is displayed.
  - b. Use the left and right cursor keys to select your **Personal** directory.
  - a. Use the up and down cursor keys to scroll through the list. Alternatively, you can start dialing the name you want to display only matching entries as follows:
    - Pressing a key enters all of the characters represented by that key. Pressing another key adds the characters from that button to the previous key press.
    - For example, dialing **527** matches all names starting with **JAS** (for example "Jason") and with **KAR** (for example "Karl") plus any other letter combinations from those 3 key presses. See [How the Directory Search Works](#) on page 96.
    - To remove all the characters entered so far, press **Clear**.
  - b. To view more details of the highlighted name, press **Details**. To return to the directory press **List**.
2. Locate the required entry and press **Details**.
3. Press **More** and then **Delete**.
4. Press **Delete** again to confirm the action.

## Related links

[Contacts](#) on page 95



# Chapter 17: Using the Call Log

This menu is accessed by pressing the  key. The call log you see is a call log stored on the telephone system.

If you log in at another phone, your call history moves with you.

Your call history contains your most recent answered calls, the most recent calls you made and the most recent missed calls. If configured by the system administrator, it can also include the most recent calls missed by each hunt group of which you are a member.

## Related links



- [Missed Calls](#) on page 105
- [Missed Group Calls](#) on page 106
- [Accessing Your Call Log](#) on page 106
- [Making a Call from Your Call Log](#) on page 107
- [Viewing Call Details](#) on page 107
- [Deleting a Call from Your Call Log](#) on page 108
- [Deleting the Whole Call Log](#) on page 109
- [Adding a Call Log Call to Your Contacts](#) on page 109

---

## Missed Calls

Missed calls are calls to you that you did not answer. Your system administrator can also configure whether or not the log includes calls presented to you but are answered by someone else or by voicemail.

The  button is illuminated when you have any new missed calls in your call log. The lamp is extinguished when you have viewed the missed call in the call log or the record of that call is no longer in your call log.

The  icon is also shown at the top-right of the phone display to indicate new missed calls and shows the number of missed callers or  for more than 9 missed callers.

## Related links

- [Using the Call Log](#) on page 105

---

## Missed Group Calls

If you are a member of any hunt groups, the system administrator can configure whether or not your missed calls log should also include missed hunt groups calls.

Missed hunt group do not have to have rung at your phone. They are recorded as missed if presented to the hunt group and not answered by any of the members.





### Related links

[Using the Call Log](#) on page 105

---

## Accessing Your Call Log

### Procedure

1. Access your call log:
  - a. Press the  **CALL LOG** button.
    - If you have any new missed calls, the button is illuminated and opening the call log shows missed calls.
  - b. Use the left/right cursor keys to select the type of records shown: **All**,  **Outgoing**,  **Incoming** and  **Missed**.
  - c. Use the up/down cursor keys to scroll through the records.
2. You can use the functions listed at the bottom of the display by pressing the soft key below the function name.
  - **Call** – Make a call to the number stored in the currently displayed call log record.
  - **Details** – Display more details about the current call log record. You can also add the caller details to your personal directory if required.
  - **More** – Switch between the different sets of available soft key functions.
  - **Delete** – Deletes the currently displayed record.
  - **Del All** – Delete all the call log records, not just the current types of records being shown.
  - **+Contact** – Add the currently highlighted call log record to your personal contacts.
3. To exit the call log, press  **PHONE** button.

### Related links





[Using the Call Log](#) on page 105

---

## Making a Call from Your Call Log

You can use your call log to make calls.

### Procedure

1. Access your call log:
  - a. Press the  **CALL LOG** button.
    - If you have any new missed calls, the button is illuminated and opening the call log shows missed calls.
  - b. Use the left/right cursor keys to select the type of records shown: **All**,  **Outgoing**,  **Incoming** and  **Missed**.
  - c. Use the up/down cursor keys to scroll through the records.
2. Press **Call** to call the number displayed in the call record. This option is not available if the caller withheld their number.

### Related links





[Using the Call Log](#) on page 105

---

## Viewing Call Details

You can view additional details about the currently shown call.

### Procedure

1. Access your call log:
  - a. Press the  **CALL LOG** button.
    - If you have any new missed calls, the button is illuminated and opening the call log shows missed calls.
  - b. Use the left/right cursor keys to select the type of records shown: **All**,  **Outgoing**,  **Incoming** and  **Missed**.
  - c. Use the up/down cursor keys to scroll through the records.
2. Press the **Details** soft key. The individual details of the currently selected call record are displayed. The possible values are:
  - **Name** - The name of the caller if known.
  - **Number** - The number of the caller if available.
  - **Time and Date** - The time of the call.
  - **Call Type Icon** - The type of call record.

- **Count** - How many time a call of the same type, name and number has occurred. Only the details of the most recent call are kept in your call log. However the count indicates if the caller has rung or has been rung several times.
  - **Duration** - The length of the call.
3. While you are in the details of a call record, the soft key functions available are:
- **Call** – Make a call to the number stored in the currently displayed call log record.
  - **List** - Go back to the normal call screen to select another call record. You can also use the up and down cursor keys to view the previous or next record.
  - **Delete** – Deletes the currently displayed record.
  - **More** – Switch between the different sets of available soft key functions.
  - **Del All** – Delete all the call log records, not just the current types of records being shown.
  - **+Contact** – Add the currently highlighted call log record to your personal contacts.

#### Related links





[Using the Call Log](#) on page 105

---

## Deleting a Call from Your Call Log

You can delete the currently displayed call record. If the record is a missed hunt group call, the record is also deleted from the call log of other users configured to see the same hunt group's missed calls.

### Procedure

1. Access your call log:
  - a. Press the  **CALL LOG** button.
    - If you have any new missed calls, the button is illuminated and opening the call log shows missed calls.
  - b. Use the left/right cursor keys to select the type of records shown: **All**,  **Outgoing**,  **Incoming** and  **Missed**.
  - c. Use the up/down cursor keys to scroll through the records.
2. When the required record is highlight, press **More** and then press **Delete**.

#### Related links





[Using the Call Log](#) on page 105

---

## Deleting the Whole Call Log

You can delete all call records from your call log. This action deletes all call logged , not just the type you are currently viewing.

### Procedure

1. Access your call log:
  - a. Press the  **CALL LOG** button.
    - If you have any new missed calls, the button is illuminated and opening the call log shows missed calls.
  - b. Use the left/right cursor keys to select the type of records shown: **All**,  **Outgoing**,  **Incoming** and  **Missed**.
  - c. Use the up/down cursor keys to scroll through the records.
2. When the required record is highlight, press **More** and then press **Del All**.

### Related links





[Using the Call Log](#) on page 105

---

## Adding a Call Log Call to Your Contacts

You can add a name and number shown in your call log to your personal contacts.

### Procedure

1. Access your call log:
  - a. Press the  **CALL LOG** button.
    - If you have any new missed calls, the button is illuminated and opening the call log shows missed calls.
  - b. Use the left/right cursor keys to select the type of records shown: **All**,  **Outgoing**,  **Incoming** and  **Missed**.
  - c. Use the up/down cursor keys to scroll through the records.
2. Press **More** and then press the **+Contact** soft key.
3. Use the up and down cursor keys to switch between the name and number details for the new contact.
4. Using the telephone keypad and the **Bksp** soft key you can edit the name and the number. See [Entering Text Characters](#) on page 198.
5. When the name and number are set as required, press the **Save** soft key. To return without saving the name and number, press the **Cancel** soft key.

Using the Call Log

**Related links**

[Using the Call Log](#) on page 105

# Part 5: Voicemail

# Chapter 18: Voicemail

If your telephone system includes a voicemail server, pressing the  **MESSAGE** button accesses voicemail. Your system administrator can configure whether that access uses either spoken prompts from the voicemail server or visual menus on the phone called 'visual voice'. This guide assumes the default operation of using the visual voice menus.

This guide covers just the visual voice functions that you can use from the phone's menus. For the full range of mailbox controls that you may be able to use, contact your system administrator for the mailbox user guide appropriate to the type of voicemail server and mailbox mode that your system uses.

## Related links

- [Message Waiting Indication](#) on page 112
- [Accessing the Visual Voice Menus](#) on page 113
- [Checking Messages Using Visual Voice](#) on page 113
- [Leaving a Message](#) on page 114
- [Using Voicemail Email](#) on page 115
- [Recording Your Mailbox Greeting](#) on page 115
- [Record Your Name](#) on page 116
- [Changing Your Voicemail Code](#) on page 117
- [Switching Voicemail On/Off](#) on page 117
- [Transferring a Call to Voicemail](#) on page 118
- [Sending an Incoming Call to Your Mailbox](#) on page 118
- [Voicemail Short Codes](#) on page 118
- [Other Mailbox Guides](#) on page 119

---

## Message Waiting Indication

The message lamp on your phone is used to indicate when you have new messages in your voicemail mailbox.

The system administrator can also configure it so that you receive new message waiting indications for hunt groups or other users.

## Related links

- [Voicemail](#) on page 112



---

## Accessing the Visual Voice Menus

Normally, pressing the  **MESSAGE** key accesses your phone's visual voice menus. However, if your system has been configured to use spoken prompts by default, you can still access the visual voice menus by using the following process.

- The number of simultaneous users using voicemail can be limited by the system licenses. In order to prevent licenses being used unnecessarily, the phone will automatically exit the visual voice menus after 10 minutes if idle.

### Procedure

1. Press the **Features** soft key if shown.
  - To do this during a call, press the  **PHONE** key and then press **Features**.
2. Use the cursor keys to select **Visual Voice**.
  - Depending on how your system is configured, you may be required to enter your voicemail password and then press **Done**.

### Related links

[Voicemail](#) on page 112

---

## Checking Messages Using Visual Voice

### Procedure

1. Press the  **MESSAGE** button.
  - Depending on how your system is configured, you may be required to enter your voicemail password and then press **Done**.
2. The **Visual Voice** menu is displayed.
3. The numbers shown against the **Listen** option indicate the number of new, old, and saved messages in your mailbox.
  - If the system administrator has configured you to receive message waiting indication for any other users and/or hunt group mailboxes, you can also use the up and down cursor keys to highlight their names access the messages in those mailboxes.
4. Highlight **Listen** and press **Select**
5. Use the up and down cursor keys to highlight which messages (**New**, **Old** or **Saved**) you want to listen to and press **Select**. The details of the first message of that type are displayed.
6. You can use the up and down cursor keys to scroll through the messages.
7. Use the soft keys to control the playback actions for the currently highlighted message:
  - To select the next message or previous message, use the up and down cursor keys.

- To fast forward or rewind the current playing message by 5 seconds, use the left and right cursor keys.
- **Call** – Call the person who left the message.
- **Back** – Return to the previous menu.
- **Play/Pause** – Start/stop playback of the currently displayed message.
- **Delete** – Delete the message.
- **Save** – Mark the message as saved. Saved messages are not normally automatically deleted.
- **Copy** – Copy the message to another mailbox. The menu prompts you to enter the destination number.

#### Related links

[Voicemail](#) on page 112

---

## Leaving a Message

You can use visual voice to record and send a voicemail message to other users' mailboxes.

#### Procedure

1. Press the  **MESSAGE** button.
  - Depending on how your system is configured, you may be required to enter your voicemail password and then press **Done**.
2. The **Visual Voice** menu is displayed.
3. Use the cursor keys to select **Message**.
4. Press **Record** to start recording a messages.
5. To stop recording, press **Stop**.
6. You can now use the following soft keys:
  - **New** – Record the message again.
  - **Send To** – Enter the number to which you want to send the message and press **Add**. You can add several numbers. When the list of numbers to which the message should be sent is complete press **Send**.
  - **Play** – Listen to the recording.
  - **Cancel** – Abandon the message.

#### Related links

[Voicemail](#) on page 112

---

## Using Voicemail Email

Voicemail email is a feature where emails are sent to your email address when your voicemail mailbox receives a new voicemail message. The email can include the voicemail message as an attachment or it can be just an alert.

### Procedure

1. Press the  **MESSAGE** button.
  - Depending on how your system is configured, you may be required to enter your voicemail password and then press **Done**.
2. The **Visual Voice** menu is displayed.
3. Use the up and down cursor keys to scroll to the option **Email**. This option is only available if your email address has been set in your voicemail settings by the system administrator.
4. The menu displays your current voicemail email mode setting. Press **Change** to scroll through the possible settings:
  - **Off** - Do not send any emails.
  - **Copy** - Send an email with a copy of the new voicemail message attached.
  - **Forward** - Send an email with the new voicemail message attached and delete the message from the voicemail mailbox.
  - **Alert** - Send an email telling you there is a new message but do not attach a copy of the message.
5. When the required setting is displayed, press **Save**. To exit without changing the setting, press **Cancel**.

### Related links

[Voicemail](#) on page 112

---

## Recording Your Mailbox Greeting

Whilst the voicemail system plays a generic greeting to callers, prompting them to leave a message, you can replace it with your own greeting for your mailbox.

### Procedure

1. Press the  **MESSAGE** button.
  - Depending on how your system is configured, you may be required to enter your voicemail password and then press **Done**.
2. The **Visual Voice** menu is displayed.
3. Use the up and down cursor keys to select **Greeting** and press **Select**.

4. Use the soft keys to listen to and record your mailbox greeting:
  - **Record** - Record a new greeting. Note that the greeting must be at least three seconds long or the voicemail system discards it.
  - **Listen** - Listen to the current greeting or the new greeting just recorded.
  - **Submit** - Submit the new recording as your mailbox greeting.
  - **Delete** - Delete your mailbox greeting. Your mailbox returns to using the system's default mailbox greeting.
  - **Cancel** - Cancel any new recording and return to the main visual voice menu.

#### Related links

[Voicemail](#) on page 112

---

## Record Your Name

Use the following procedure to record a mailbox name. This feature is only available on systems using Embedded Voicemail.

#### Procedure

1. Press the  **MESSAGE** button.
  - Depending on how your system is configured, you may be required to enter your voicemail password and then press **Done**.
2. The **Visual Voice** menu is displayed.
3. Use the cursor keys to select **Name**.
4. Use the soft keys to listen to and record your mailbox name:
  - **Record** - Record a new name.
  - **Listen** - Listen to the existing recording or the one just recorded.
  - **Submit** - Submit the new recording as your mailbox name.
  - **Delete** - Delete your current name.
  - **Cancel** - Cancel any new recording and return to the main visual voice menu.

#### Related links

[Voicemail](#) on page 112

---

## Changing Your Voicemail Code

### Procedure

1. Press the  **MESSAGE** button.
  - Depending on how your system is configured, you may be required to enter your voicemail password and then press **Done**.
2. The **Visual Voice** menu is displayed.
3. Use the cursor keys to select **Password**.
4. Enter your current password and press **Save**.
5. Enter the new password that you want to use. When the desired password is complete, press **Save**.
  - Your system administrator can set rules for the required length of the code and to block the use of obvious codes (1234, 1111). You cannot save a new code until those requirements have been met. Contact your system administrator for details of your system's settings if necessary.

### Related links

[Voicemail](#) on page 112

---

## Switching Voicemail On/Off

You can control whether the telephone system uses voicemail to answer your unanswered calls. This does not switch off your mailbox which you can still access to play existing messages and use other functions.

### Procedure

1. Press the  **MESSAGE** button.
  - Depending on how your system is configured, you may be required to enter your voicemail password and then press **Done**.
2. The **Visual Voice** menu is displayed.
3. Use the up and down cursor keys to highlight **Voicemail**.
4. Press the **Change** to switch between **On** or **Off**.
5. Press **Save** to save the change.

### Related links

[Voicemail](#) on page 112

---

## Transferring a Call to Voicemail

When set to visual voice mode, the  **MESSAGE** key can be used to transfer your current call to the voicemail mailbox of another user or group.

### Procedure

1. With the call connected, press the  **MESSAGE** key. You are still connected to the call and can continue talking.
2. Dial the extension number of the user or group to which you want to transfer the call.
3. When the number matches a user or group, their name is displayed.
  - To transfer the call to the user or group's mailbox, press **Select**. The caller hears a few seconds of ringing and then the mailbox greeting.
  - To cancel the transfer, press **Cancel**.

### Related links

[Voicemail](#) on page 112

---

## Sending an Incoming Call to Your Mailbox

You can transfer a call targeted at you directly to your voicemail mailbox.

### Procedure

1. If the call is not the currently highlighted call on the display, use the up and down cursor keys to highlight it.
2. Press the **ToVM** soft key. The call is redirected to your mailbox.

### Related links

[Voicemail](#) on page 112

---

## Voicemail Short Codes

Short codes are numbers that you can dial to enable and disable various features. The following are default short codes that may be available. However, your system administrator can remove and change the short codes available to you or all users. To use a short code, you may have to put your currently call on hold.

These are useful as they can be dialed from any phone on the system. For example, this allows you to login at a basic analog extension and still control a number of features.

Some short codes require you to enter some information when you dial them, typically an extension number. That is indicated by **N** in the short codes shown below.

- For a list of other common dialing short codes, see [Short Codes](#) on page 176.

### Voicemail

- **Check Messages: \*17** – Access mailboxes to check for messages.
- **Voicemail On: \*18** – Allow voicemail to be used to answer calls.
- **Voicemail Off: \*19** – Stop voicemail being used to answer calls.
- **Voicemail Ringback On: \*48** – Have voicemail ring your phone when you have any new messages. It rings after you next use the phone.
- **Voicemail Ringback Off: \*49** – Switch off ringback.

### Related links

[Voicemail](#) on page 112

---

## Other Mailbox Guides

In addition to accessing messages from the phone's menus, you can dial \*17 to access your mailbox through spoken menu prompts. Your system administrator can also configure methods to access the spoken mailbox prompts remotely.

Depending on the voicemail server being used and the mode it is running in, use one of the following user guides to understand the features available:

- [Using IP Office Embedded Voicemail IP Office Mode](#)
- [Using IP Office Embedded Voicemail Intuity Mode](#)
- [Using a Voicemail Pro Intuity Mode Mailbox](#)
- [Using a Voicemail Pro IP Office Mode Mailbox](#)

### Related links

[Voicemail](#) on page 112

# Part 6: Other Features



# Chapter 19: Account Codes

The telephone system can store a number of account codes. Account codes may be used to keep track of calls in relation to particular activities or clients. They can also be used to keep track of calls by particular users or sets of users.

- When an account code is entered while making a call or during a call, that account code is included in the call records output by the system.
- Accounts entered are checked against those stored by the telephone system. If an invalid code is entered, the account code is requested again.
- The system administrator can configure certain numbers or types of numbers to require entry of an account code before you can continue making a call to such a number.
- The system administrator can also configure a requirement for you to enter an account code before making any external call.

## Related links

[Forced Account Codes](#) on page 121

[Manual Account Code Entry](#) on page 122

---

## Forced Account Codes

The system administrator can configure certain numbers or types of numbers to require entry of an account code before you can continue making a call to such a number.

### Procedure

1. The **Account Code** menu is displayed when you are required to enter an account code.
2. Enter the account code that you want to use.
3. Press the **Done** soft key.
4. If the account code was not a valid account code, the **Reenter Account** menu is displayed.

## Related links

[Account Codes](#) on page 121

---

## Manual Account Code Entry

You can enter account codes during a call or before making a call. The account code that you enter must match an account code set on the telephone system.

- Your system administrator can configure whether you can access this menu.
- This menu is not supported on the J139.
- Access to this menu can be assigned to a programmable button configured with the **Account Code** action. See [Programmable Feature Buttons](#) on page 167.

### Procedure

1. Press the **Features** soft key if shown.
  - To do this during a call, press the  **PHONE** key and then press **Features**.
2. Use cursor keys to select **Call Settings**.
3. Use the up and down cursor keys to highlight **Account Code**.
4. Press the **Set** soft key.
5. Enter the account code that you want to use.
6. Press the **Done** soft key.
7. If the account code was not a valid account code, the **Failed** menu is displayed.

### Related links

[Account Codes](#) on page 121

# Chapter 20: Headset Operation

Your phone has a headset socket. This is suitable for the connection of phone headsets that connect via a HIS headset cable.

- The J179 and J189 also support Bluetooth headsets if the optional wireless module is installed in the phone.
- If there are no currently connected call, a call answered or made by pressing an appearance button is connected either handsfree or through the headset according to the phone's audio path setting. See [Default Handsfree Audio Path](#) on page 127. The same applies to dialing a new call.
- If there is already a connected call to which you are talking through the headset, answering another call by pressing the appearance button answers that call using the headset.

## Related links

[Using a Heaset](#) on page 123

[Headset Selection](#) on page 124

[Headset Caller Volume](#) on page 124

[Headset Microphone Volume](#) on page 125

[Headset Profile](#) on page 125

[Automatic Gain Control](#) on page 126





[Default Handsfree Audio Path](#) on page 127



[Using Bluetooth Headsets](#) on page 127

[Headset Alert Sounds](#) on page 129

---

## Using a Heaset

- **To answer a call using a headset:** Press the  **HEADSET** button.
- **To end a headset call:** Press the  **HEADSET** button. If the other party ends the call, the  **HEADSET** button remains active. Press the button to end the headset usage.
- **To switch from the headset to the handset:** To switch from the headset to the handset, simply lift the handset.
- **To switch to handsfree from the headset:** To switch to handsfree from the headset, press the  **HEADSET** button. Replace the handset.

- **To switch from the headset to handsfree:** Press the  **SPEAKER** button. See [Handsfree Speaker Operation](#) on page 131.
- **To switch to headset from handsfree:** Press the  **HEADSET** button. The button remains lit whilst you have a call connected handsfree.
- **To mute the call while on the headset:** Press the  **MUTE** button. The button remains lit whilst the call is muted.

#### Related links

[Headset Operation](#) on page 123

---

## Headset Selection

The J179 and J189 can support both traditional wired telephony headsets and, if fitted with the optional wireless module, Bluetooth headsets. You can indicate which type the of headset the phone should use.

#### Procedure

1. Press the  button.
2. Use the cursor keys to select **Settings**.
3. Use the cursor keys to select **Audio**.
4. Use the cursor keys to select **Headset selection**.
5. Use the cursor keys to switch between **Bluetooth** or **Wired**.
6. When completed, press **Save**.
7. Press **Back/Exit** to exit the menus.

#### Related links

[Headset Operation](#) on page 123

---

## Headset Caller Volume

While talking via the headset, you can adjust the volume of the caller.

#### Procedure

1. Use the **+** plus and **-** minus keys to adjust the volume.
2. Once you stop adjusting the volume, the display returns to normal after a few seconds.
  - If you set the volume to zero (off), the phone displays a  icon.

**Related links**

[Headset Operation](#) on page 123

---

## Headset Microphone Volume

If necessary, you can adjust the gain that the phone applies to your speech on the headset. This is separate to the headset's own volume control.

**Procedure**

1. Press the **≡** button.
2. Use the cursor keys to select **Settings**.
3. Use the cursor keys to select **Audio**.
4. Use the cursor keys to select **Headset mic level**.
5. Use the left and right cursor keys to change the gain.
  - Press **Default** to reset the gain to its normal default.
  - Press **Back** to save the selected level.
6. When completed, press **Save**.
7. Press **Back/Exit** to exit the menus.

**Related links**

[Headset Operation](#) on page 123

---

## Headset Profile

The phone supports headsets from a range of suppliers. For optimal sound and performance, the phone's headset profile setting may need to be changed to match the headset.

The following is a list of the headsets tested and supported by Avaya and their matching profile setting. Other headsets may also work but have not been tested by Avaya.

Profile	Headsets
1	• Default
2	• <b>Plantronics:</b> SupraPlus Wideband HW251N/HW261N (HIS). • <b>Sennheiser:</b> SH330, SH350, CC510, CC550 (CAVA-31).
3	• <b>Plantronics:</b> EncorePro HW291N/HW301N (HIS). • <b>Sennheiser:</b> Circle SC230/260 (CAVA-31).

*Table continues...*

Profile	Headsets
4	<ul style="list-style-type: none"> <li>• <b>Jabra:</b> BIZ 2400 (GN1216).</li> <li>• <b>Sennheiser:</b> Century SC630/660 (CAVA-31).</li> <li>• <b>VXI:</b> CC Pro 4010V DD, CC Pro 4021V DC (OmniCord-V).</li> </ul>
5	<ul style="list-style-type: none"> <li>• <b>Jabra:</b> GN2000 (GN1216).</li> </ul>
6	<ul style="list-style-type: none"> <li>• <b>Jabra:</b> PRO 9470 (14201-33).</li> </ul>
7	<ul style="list-style-type: none"> <li>• <b>Plantronics:</b> CS500 Series CS510, CS520, CS530, CS540 (APV-63). Savi 700 Series - W710, W720, W730, W740, W745 (APV-63).</li> </ul>
8	<ul style="list-style-type: none"> <li>• <b>Sennheiser:</b> DW Pro1, DW Pro2, DW Office, SD Pro1, SD Pro2, SD Office (CEHS-AV03/AV04).</li> </ul>

### Procedure

1. Press the **≡** button.
2. Use the cursor keys to select **Settings**.
3. Use the cursor keys to select **Audio**.
4. Use the cursor keys to select **Headset profile**.
5. Select the profile required.
6. When completed, press **Save**.
7. Press **Back/Exit** to exit the menus.

### Related links

[Headset Operation](#) on page 123

---

## Automatic Gain Control

When using automatic gain control (AGC), the phone tries to maintain a constant audio level even if the incoming call changes between loud and quiet.

### Procedure

1. Press the **≡** button.
2. Use the cursor keys to select **Settings**.
3. Use the cursor keys to select **Audio**.
4. Use the cursor keys to select **Automatic gain control**.
5. Use the cursor keys to switch between **Handset**, **Headset**, or **Speaker**.
6. To change the highlighted setting, press **Toggle**.
7. When completed, press **Save**.

8. Press **Back/Exit** to exit the menus.

**Related links**

[Headset Operation](#) on page 123

---

## Default Handsfree Audio Path

By default, when you make a call or answer a call without lifting the handset, the audio is played through the phone's speaker while you speak via the phone's microphone.

If you have a headset attached, you can change the phone's behavior so that the audio is played through the headset by default rather than the speaker.

**Procedure**

1. Press the **≡** button.
2. Use the cursor keys to select **Settings**.
3. Use the cursor keys to select **Audio**.
4. Use the up and down cursor keys to highlight **Audio path**.
5. Use the left and right cursor keys to switch between **Headset** or **Speaker**.
6. When completed, press **Save**.
7. Press **Back/Exit** to exit the menus.



**Related links**

[Headset Operation](#) on page 123

---

## Using Bluetooth Headsets

An optional wireless module can be added to J179 and J189 telephones. This allows it to support up to 10 wireless Bluetooth headsets (one connected at any time).

- When enabled, a  icon is displayed at the top of the phone display.
- This changes to a  icon when a Bluetooth headset is connected to the phone.
- The J179 and J189 can support both Bluetooth and traditional wired telephony headsets. You need to indicate which type of headset the phone should use. See [Headset Selection](#) on page 124.

**Related links**

[Headset Operation](#) on page 123

[Enabling Bluetooth Support](#) on page 128

[Pairing a Bluetooth Headset](#) on page 128

[Selecting a Paired Headset](#) on page 129

---

## Enabling Bluetooth Support

Use the following process to enable Bluetooth support.

### Procedure

1. Press the **≡** button.
2. Use the cursor keys to select **Settings**.
3. Use the cursor keys to select **Bluetooth**.
4. Select **Bluetooth headset** and change the setting on or off as required.
  - When on, you can use the **Devices** option to pair a Bluetooth headset and to select the currently connected headset.

### Related links

[Using Bluetooth Headsets](#) on page 127

---

## Pairing a Bluetooth Headset

Before using the following process, put the headset into pairing mode using the headset manufacturer's instructions

### Procedure

1. Press the **≡** button.
2. Use the cursor keys to select **Settings**.
3. Use the cursor keys to select **Bluetooth**.
4. Click on **Scan**.
5. The phone scans for available Bluetooth headset devices. When the headset is detected, its name appears in the list of paired devices.
6. Select the required headset and click **Pair**.
  - Once paired, you can highlight the device and click **Forget** if you want to remove the pairing.

### Related links

[Using Bluetooth Headsets](#) on page 127



---

## Selecting a Paired Headset

The phone can support up to 10 paired headsets. However, only one can be currently connected at any time. This process allows you to select which of the paired headsets to connect.

If the selected headset has been out of range, it should reconnect automatically. However, this process can also be used to manually re-establish the connection if required.

### Procedure

1. Press the **≡** button.
2. Use the cursor keys to select **Settings**.
3. Use the cursor keys to select **Bluetooth**.
4. Highlight the required headset. Click **Connect**. That headset becomes the currently connected device.
5. To disconnect a device without removing its pairing, highlight it and click **Disconct**.
6. Highlighting a device and clicking **Forget** removes the devices pairing. Only do this if you don't expect to use that device again. If done by mistake, the device needs to be paired again.

### Related links

[Using Bluetooth Headsets](#) on page 127

---

## Headset Alert Sounds

When using a headset, the phone can provide additional audio alerts through that headset, These alerts are in addition to the phone's normal visual alerting and ringer.

The phone can provide headset alerts when it goes off and on hook. It can also provide a headset alert when calls are waiting to be answered. That includes calls waiting to be answered when you already have a call connected.

### Procedure

1. Press the **≡** button.
2. Use the cursor keys to select **Settings**.
3. Use the cursor keys to select **Audio**.
4. Select **Headset Signalling**.
5. Select the headset alerting mode required:
  - **Disabled** – The phone does not provide any additional alert sounds through the headset.

- **Switch hook only** – The phone provides alerts sounds when the phone goes off-hook (a single click) or back on-hook (a double click).
  - **Switch hook and alert** – The phone provides alerts as above plus an additional alert (three clicks) whenever a call is waiting to be answered.
6. When completed, press **Save**.
  7. Press **Back/Exit** to exit the menus.

**Related links**

[Headset Operation](#) on page 123

# Chapter 21: Handsfree Speaker Operation

Your phone has a speaker and microphone that allows you make and answer calls handsfree. The speaker is located under the handset. The microphone is located near the bottom right of the phone's keypad.

- If there are no currently connected calls to which you are talking, a call answered by pressing its appearance button is connected either handsfree or through the headset according to the phone's audio path setting.
- If there is already a connected call to which you are talking handsfree, answering another call by pressing the appearance button answers that call handsfree.

## Conference Phones

Your phone is not designed as a conference room speakerphone. It is designed for use by a user located directly in front of the phone, with no obstructions between themselves and the microphone. Phones designed to be used as conference speakerphones typically have multiple microphones and are able to handle sounds coming from multiple directions. For details of conference speakerphones supported by your phone system, contact your system administrator.

## Related links

[Using Handsfree](#) on page 131

[Speaker Volume](#) on page 132

[Default Audio Path](#) on page 132

[Automatic Gain Control](#) on page 133



---

## Using Handsfree

### Procedure

Use the following options to work handsfree:

- **To answer a call handsfree:** Press the  **SPEAKER** button. The button remains lit whilst you have a call connected handsfree.
- **To end a handsfree call:** Press the  **SPEAKER** button again.
- **To switch from handsfree to the handset:** Simply lift the handset.
- **To switch to handsfree from the handset:** Press the  **SPEAKER** button. The button remains lit whilst you have a call connected handsfree. Replace the handset.

- **To switch from handsfree to the headset:** Press the  **HEADSET** button. See [Headset Operation](#) on page 123.
- **To mute the call while handsfree:** Press the  **MUTE** button.

#### Related links

[Handsfree Speaker Operation](#) on page 131

---

## Speaker Volume

While talking via the speaker, you can adjust the volume of the caller.

#### Procedure

1. Use the + plus and – minus keys to adjust the volume.
2. Once you stop adjusting the volume, the display returns to normal after a few seconds.
  - If you set the volume to zero (off), the phone displays a  icon.

#### Related links

[Handsfree Speaker Operation](#) on page 131

---

## Default Audio Path

By default, when you make a call or answer a call without lifting the handset, the audio is played through the phone's speaker while you speak via the phone's microphone.

If you have a headset attached, you can change the phone's behavior so that the audio is played through the headset by default rather than the speaker.

#### Procedure

1. Press the  button.
2. Use the cursor keys to select **Settings**.
3. Use the cursor keys to select **Audio**.
4. Use the up and down cursor keys to highlight **Audio path**.
5. Use the left and right cursor keys to switch between **Headset** or **Speaker**.
6. When completed, press **Save**.
7. Press **Back/Exit** to exit the menus.

#### Related links

[Handsfree Speaker Operation](#) on page 131

---

## Automatic Gain Control

When using automatic gain control (AGC), the phone tries to maintain a constant audio level even if the incoming call changes between loud and quiet.

### Procedure

1. Press the **≡** button.
2. Use the cursor keys to select **Settings**.
3. Use the cursor keys to select **Audio**.
4. Use the cursor keys to select **Automatic gain control**.
5. Use the cursor keys to switch between **Handset**, **Headset**, or **Speaker**.
6. To change the highlighted setting, press **Toggle**.
7. When completed, press **Save**.
8. Press **Back/Exit** to exit the menus.

### Related links

[Handsfree Speaker Operation](#) on page 131

# Chapter 22: Logging In/Out

You may always use the same phone in the same location. However, the telephone system provides a number of features that allow you to use any phone on the system to make and receive calls.

## Log In

You can log in at any phone that you want to use. All your calls are then redirected to that phone and your user settings are applied to calls made and received. If it is a phone that stores your contacts and call history on the system, your contacts and call log are displayed by the phone.

- Any other existing user of that phone is logged out while you are logged in.
- If you were logged in on another phone, you are logged out from it.
- If your phone system is in a network of phone systems, it may be possible to log in at extensions located on other phone systems in the network. Your system administrator will advise if you can 'remote hot desk' and what features are available to you when you do.

## Log Out

When you log out from a phone, or are logged out by another user logging in, the telephone system may apply several actions:

- If you have a normal default extension and no one else is logged in there, you return to being logged in on that phone.
- If you remain logged out, you are treated the same as being on 'do not disturb', except that all calls to you go to voicemail if available.
- If you have a mobile twinned number, the system administrator can configure the system so that calls are still presented to your mobile twin while you are logged out.
- Your system administrator can configure a timeout which automatically logs you out if you do not use the phone in that time to make or answer a call.

## Lock/Unlock

Separately from logging in and out, you can lock your phone settings. While locked, the phone can still be used to answer your calls and can be used to make internal and emergency calls. However it cannot be used to make external calls and your user settings cannot be accessed through the phones menus.

- You can set your phone to automatically lock itself after a period of inactivity.

## Related links

[Logging In](#) on page 135

[Logging Out](#) on page 137

[Changing Your Security PIN](#) on page 137

[Locking Your Phone](#) on page 138

[Unlocking Your Phone](#) on page 138

[Auto Lock](#) on page 139

[Login Short Codes](#) on page 140

---

## Logging In

When you log in to a phone, you take control of that phone. Incoming calls for you are redirected to that phone and your user information and settings are available. Any existing user on the phone is logged off when you log in.

The method for logging in depends on the current state of the phone:

- **Phone In Use** – If the phone is already in use you can still login. The existing user is logged out.
- **Logged Out - Not Logged In** – If the phone has no current user, it displays a basic menu with just the **Login** option is displayed. Note that in this state the phone can still be used to make internal and emergency calls.

### Related links

[Logging In/Out](#) on page 134

[Logging In on Another User's Phone](#) on page 135

[Logging In on a "Not Logged In" Phone](#) on page 136

[Logging In on an Unregistered Phone](#) on page 136

---

## Logging In on Another User's Phone

You can login at a phone that is already in use by another user. The existing user is logged out.

### Procedure

1. Press the **Features** soft key.
2. Use the cursor keys to select **Mobile Twinning**.
3. Use the cursor keys to select **Login**.
4. The login menu is displayed.
  - a. Enter your extension number and press **Next** .
  - b. Enter your security PIN (login code).
  - c. Press **Done**.

### Related links

[Logging In](#) on page 135

## Logging In on a “Not Logged In” Phone

This method is used to login at an extension where the previous user has logged out and the phone has no current user. You can recognize a phone in this state by **NOT LOGGED IN** on the display.

### Procedure

1. Press **Login**.
2. The login menu is displayed.
  - a. Enter your extension number and press **Next** .
  - b. Enter your security PIN (login code).
  - c. Press **Done**.

### Related links

[Logging In](#) on page 135

---

## Logging In on an Unregistered Phone

This method is used to login at an unregistered phone. You can recognize an unregistered phone by **Enter Extension** on the display. This method is not supported for hot desking, you can only log in using the base extension number originally used to install the phone.

### Procedure

1. Enter your extension number. As you enter it, you can use the **Bksp** and **Clear** soft keys to make corrections.
2. When your number is displayed, press the **OK** soft key.
3. Enter the phone password. Use the **Bksp** and **Clear** soft keys to make corrections. This password is determined by your system administrator and is required for registration.
4. When you have entered the phone password, press **Done**. If the details are correct, you user details are loaded into the phone.

### Related links

[Logging In](#) on page 135



---

## Logging Out

Logging out using the method below disassociates you from the extension. What happens then depends on whether you are the default user of another extension and various other settings.

- This menu is only available if you already have a security PIN/login code set.
- Your system administrator can configure whether you can access this menu.

### Procedure

1. Press the **Features** soft key if shown.
  - To do this during a call, press the  **PHONE** key and then press **Features**.
2. Use the cursor keys to select **Phone User**.
3. Use the cursor keys to select **Logout**.
4. You are logged out of the phone. The results depend on several factors:
  - If the phone does not have a default user, or the default user is currently logged on elsewhere, the phone displays **NoUser**.
  - If the phone has a default user and they are not current logged on elsewhere, they are automatically logged back in unless they are set to forced login.
  - If you are the default user of another extension that is free (doesn't have anyone else logged in to it), you are automatically logged back in to that extension unless you are set to forced login.

### Related links

[Logging In/Out](#) on page 134

---

## Changing Your Security PIN

You can change your own security PIN (login code). This is not your voicemail code used for voicemail access. If set, this PIN is used for logging in at other phones, locking your phone, and accessing system administration features.

### Procedure

1. Press the **Features** soft key if shown.
  - To do this during a call, press the  **PHONE** key and then press **Features**.
2. Use the cursor keys to select **Phone User**.
3. Use the cursor keys to select **Set Security Pin**.
4. Enter your current security PIN if you already have one and press **Done**.

5. Enter your new security PIN.

- Your system administrator can set rules for the required length of the code and to block the use of obvious codes (1234, 1111). You cannot save a new code until those requirements have been met. Contact your system administrator for details of your system's settings if necessary.

6. Press **Save**.

**Related links**

[Logging In/Out](#) on page 134

---

## Locking Your Phone

Rather than logging out, you can lock your phone. You can either lock your phone manually using the steps below or have it automatically locked after a period of phone inactivity. To use the lock feature you need to set a security PIN (you can lock the phone with a code but anyone can also unlock it).

When your phone is locked:

- It can only be used to make internal and emergency calls.
- None of the menus for your user settings can be accessed.
- Unlocking the phone requires your configured login code.

**Procedure**

1. Press the **Features** soft key if shown.
  - To do this during a call, press the  **PHONE** key and then press **Features**.
2. Use the cursor keys to select **Phone User**.
3. Use the up and down cursor keys to highlight **Lock**. Press the **SelectSelect**.
4. The phone is now locked and displays **Phone Locked**.

**Related links**

[Logging In/Out](#) on page 134

---

## Unlocking Your Phone

The message **PHONE LOCKED** indicates that the phone has been locked. While locked, the phone can only be used to make internal calls to other extensions and none of the phone and user menus can be accessed.

## Procedure

1. Press the **Unlock** soft key.
2. Enter your security PIN (login code).
3. Press the **Done** soft key.

## Related links

[Logging In/Out](#) on page 134

---

# Auto Lock

Rather than logging out, you can lock your phone. You can either lock your phone manually using the steps below or have it automatically locked after a period of phone inactivity. To use this feature you need a security PIN (login code) set.

When your phone is locked:

- It can only be used to make internal and emergency calls.
- None of the menus for your user settings can be accessed.
- Unlocking the phone requires your configured login code.
- Your system administrator can configure whether you can access this menu.

## Procedure

1. Press the **Features** soft key if shown.
  - To do this during a call, press the  **PHONE** key and then press **Features**.
2. Use the cursor keys to select **Phone User**.
3. Use the cursor keys to select **Phone Screen Settings**.
4. Use the up and down cursor keys to highlight **Auto Lock (minutes)**.
5. Press the **Change** soft key to change the setting or use the left or right cursor keys.
  - **Disabled** - Do not use the inactivity timer.
  - **1/5/30/60** - Lock the phone after the indicated number of minutes.
6. Press the **Save** soft key.

## Related links

[Logging In/Out](#) on page 134

---

## Login Short Codes

Short codes are numbers that you can dial to enable and disable various features. The following are default short codes that may be available. However, your system administrator can remove and change the short codes available to you or all users. To use a short code, you may have to put your currently call on hold.

These are useful as they can be dialed from any phone on the system. For example, this allows you to login at a basic analog extension and still control a number of features.

Some short codes require you to enter some information when you dial them, typically an extension number. That is indicated by **N** in the short codes shown below.

- For a list of other common dialing short codes, see [Short Codes](#) on page 176.

### Login

- **Log In: \*35\*N\*P#** – Log in to a phone using your extension number (**N**) and login code (**P**).
- **Log Out: \*36** – Log yourself out from the phone where you are currently logged in.

### Related links

[Logging In/Out](#) on page 134

# Chapter 23: Groups

Your system administrator can include you as a member of a group along with other users. Each group has its own extension number which can be used as the destination for a call.

- When a call is made to a group, it is presented to the available group members, either one at a time or all at the same time, until answered by one of the members.
- How long a group call rings at each group member before being presented to the next member is controlled by the group's own settings. Hunt groups also use voicemail and have their own settings for when an unanswered call should go to the group's mailbox. For group calls, the hunt group's voicemail settings are used rather than your settings.

The system administrator can enable a number of hunt group menu options on your phone. Each option is enabled for a selected hunt group or for all hunt groups of which you are a member:

- **Enable/Disable Your Group Membership** – When your membership of a hunt group is disabled, you no longer receive hunt group calls for that group. You are still a member of the group and can re-enable your membership.
- **Change the Hunt Group Service Status** – Each hunt group can either be in service, in night service, or out of service. When in night service or out of service, the groups calls are redirected to an alternate group, or to voicemail if available.
- **Change the Hunt Group Fallback Destination** – These menus allow you to change the alternate groups used for the group's calls when it is in night service or out of service status.

## Related links

[Group Membership](#) on page 141

[Group Service Status and Fallback](#) on page 143

---

## Group Membership

Only the system administrator can change a group, the group members, or group settings. However, you can be provided with options to enable or disable your group membership. While membership to a group is disabled, you do not receive any calls for that group.

- This menu is not supported on the J139.

## Related links

[Groups](#) on page 141

[Switching Your Group Membership On/Off \(Status Menu\)](#) on page 142

[Switching Your Group Membership On/Off \(Features Menu\)](#) on page 142

---

## Switching Your Group Membership On/Off (Status Menu)

Your system administrator can grant you the ability to enable/disable your membership to a group through the Status menu. When your membership to a group is disabled, you do not receive group calls for that group.

- The system administrator is able to configure whether you have access to the **Membership**, **State** and **Fallback** options of a group. If you are not configured for any groups, the **Group** menu is not shown
- This menu is not supported on the J139.

### Procedure

1. Press the **Status** soft key if shown.
  - To do this during a call, press the  **PHONE** key and then press the **Status** soft key.
2. Use the up and down cursor keys to highlight the hunt group name and your current membership status.
3. Press the **Enabled** or **Disabled** soft key to change the status of your membership to that group.
4. Press **Exit**.

### Related links

[Group Membership](#) on page 141

---

## Switching Your Group Membership On/Off (Features Menu)

You may be able to enable or disable your group membership for some of the groups to which you belong.

- The system administrator is able to configure whether you have access to the **Membership**, **State** and **Fallback** options of a group. If you are not configured for any groups, the **Group** menu is not shown
- This menu is not supported on the J139.

### Procedure

1. Press the **Features** soft key if shown.
  - To do this during a call, press the  **PHONE** key and then press **Features**.
2. Use the cursor keys to select **Group**.
3. Use the cursor keys to select **Membership**.

4. Use the cursor keys to scroll through the list of hunt groups you can configure.
  - To change your membership to the highlighted group, press **Change**.
  - To change your membership to all groups, press **More** and then press either **All Ena** or **All Dis**.

#### Related links

[Group Membership](#) on page 141

---

## Group Service Status and Fallback

- **Group Service Status** – A hunt group can be in one of the following service modes:
  - **InS (In Service)** – The groups operates as normal, distributing calls to available members of the group.
  - **NS (Night Service)** – The group is in 'night service' mode. Calls are redirected to its night service fallback destination if set, otherwise to voicemail if available. A hunt group can also be put into and out of night service automatically by the telephone system using a time profile.
  - **OOS (Out of Service)** – The group is out of service. Calls are redirected to its out of service fallback destination if set, otherwise to voicemail if available. The phone displays an **O** when one of the groups of which your are a member is out of service.
  - **TP (Time Profile)** – This setting indicates that the group's status is being controlled by a time profile on the telephone system. That time profile sets when the group is in service and in night service. You can override this to put the group into the **Out of Service** state. You can then use the phone to returns the group to time profile control when required.
- **Fallback Destination** – For the night service and out of service states, the hunt group can be configured with a fallback destination to which its calls are redirected. This destination can be another hunt group or user extension. If no fallback destination is set, the group's voicemail is used (if available). Separate night service and out of service fallback destinations can be set for each group.

#### Related links

[Groups](#) on page 141

[Changing a Group's Service Status \(Features Menu\)](#) on page 144

[Changing a Group's Service Status \(Status Menu\)](#) on page 145

[Changing a Group's Fallback Destination](#) on page 145

[Short Codes](#) on page 146

---

## Changing a Group's Service Status (*Features Menu*)

Using the **Features** menu you may be able to change the service status of some groups to which you belong.

- The system administrator is able to configure whether you have access to the **Membership**, **State** and **Fallback** options of a group. If you are not configured for any groups, the **Group** menu is not shown
- This menu is not supported on the J139.

### Procedure

1. Press the **Features** soft key if shown.
  - To do this during a call, press the  **PHONE** key and then press **Features**.
2. Use the cursor keys to select **Group**.
3. Use the cursor keys to select **State**.
4. Use the cursor keys to scroll through the list of hunt groups you can configure. The current status of each group is shown next to the group name.
  - **InS (In Service)** – The groups operates as normal, distributing calls to available members of the group.
  - **NS (Night Service)** – The group is in 'night service' mode. Calls are redirected to its night service fallback destination if set, otherwise to voicemail if available. A hunt group can also be put into and out of night service automatically by the telephone system using a time profile.
  - **OOS (Out of Service)** – The group is out of service. Calls are redirected to its out of service fallback destination if set, otherwise to voicemail if available. The phone displays an **O** when one of the groups of which your are a member is out of service.
  - **TP (Time Profile)** – This setting indicates that the group's status is being controlled by a time profile on the telephone system. That time profile sets when the group is in service and in night service. You can override this to put the group into the **Out of Service** state. You can then use the phone to returns the group to time profile control when required.
5. Use the controls at the bottom on the display to change the currently selected group's status.
  - **Change** - Change the status of the selected group.
  - **Save** - Exit the menus.

### Related links

[Group Service Status and Fallback](#) on page 143



---

## Changing a Group's Service Status (Status Menu)

If the system administrator has allowed you, you can change the service state of a group through the **Status** menu.

### Procedure

1. Press the **Status** soft key if shown.
  - To do this during a call, press the  **PHONE** key and then press the **Status** soft key.
2. Use the up and down cursor keys to highlight the hunt group name and your current membership status.
3. Select the required state using the soft keys:
  - **InS (In Service)** – The groups operates as normal, distributing calls to available members of the group.
  - **NS (Night Service)** – The group is in 'night service' mode. Calls are redirected to its night service fallback destination if set, otherwise to voicemail if available. A hunt group can also be put into and out of night service automatically by the telephone system using a time profile.
  - **OOS (Out of Service)** – The group is out of service. Calls are redirected to its out of service fallback destination if set, otherwise to voicemail if available. The phone displays an **O** when one of the groups of which your are a member is out of service.
  - **TP (Time Profile)** – This setting indicates that the group's status is being controlled by a time profile on the telephone system. That time profile sets when the group is in service and in night service. You can override this to put the group into the **Out of Service** state. You can then use the phone to returns the group to time profile control when required.

### Related links

[Group Service Status and Fallback](#) on page 143

---

## Changing a Group's Fallback Destination

You may be able to use the **Features** menu to change the fallback destination for some hunt groups of which you are a member. These are the destinations to which the hunt groups calls are routed when it is in either night service state or the out of service state. The destination can be another group, another user or a dialing code configured by you system administrator.

- The system administrator is able to configure whether you have access to the **Membership, State** and **Fallback** options of a group. If you are not configured for any groups, the **Group** menu is not shown
- This menu is not supported on the J139.

## Procedure

1. Press the **Features** soft key if shown.
  - To do this during a call, press the  **PHONE** key and then press **Features**.
2. Use the cursor keys to select **Group**.
3. Use the cursor keys to select **Fallback**.
  - Use the left/right cursor keys to switch between altering night service or out of service settings.
  - Use the cursor keys to scroll through the list of hunt groups you can configure in the current mode.
  - To change the fallback destination of the currently highlighted hunt group, press **Edit**.
  - To change the fallback destination of all the hunt groups, press **More** and then press **Edit All**.

## Related links

[Group Service Status and Fallback](#) on page 143

---

## Short Codes

Short codes are numbers that you can dial to enable and disable various features. The following are default short codes that may be available. However, your system administrator can remove and change the short codes available to you or all users. To use a short code, you may have to put your currently call on hold.

These are useful as they can be dialed from any phone on the system. For example, this allows you to login at a basic analog extension and still control a number of features.

Some short codes require you to enter some information when you dial them, typically an extension number. That is indicated by **N** in the short codes shown below.

- For a list of other common dialing short codes, see [Short Codes](#) on page 176.

### Hunt Group

- **Night Service Status On: \*20\*N#** – Set a hunt group into night service status by entering its extension number (**N**).
- **Night Service Status Off: \*21\*N#** – Take a hunt group out of night service status by entering its extension number (**N**).

## Related links

[Group Service Status and Fallback](#) on page 143

# Part 7: Phone Configuration

# Chapter 24: Ringer Controls

This section covers controls for adjusting the ringing used by your phone.

## Related links

- [Disabling the Ringer](#) on page 148
- [Visual Alerting](#) on page 149
- [Coverage Ring](#) on page 149
- [Ringer Volume](#) on page 150
- [Internal Auto-Answer](#) on page 150

---

## Disabling the Ringer

This option can be used to turn off the ringer for all calls. If set to no ring, this disables both the phone's audible alerting and visual alerting.

- This menu is not supported on the J139.
- You can also set the ring volume to zero. If so, the phone displays a  icon but still provides visual alerting.

### Procedure

1. Press the **Features** soft key if shown.
  - To do this during a call, press the  **PHONE** key and then press **Features**.
2. Use cursor keys to select **Call Settings**.
3. Use the cursor keys to select **Disable Ringer**.
4. To change the setting, press **Change**. Selecting **On** turns the ringer off.

## Related links

- [Ringer Controls](#) on page 148

---

## Visual Alerting

The message waiting lamp at the top-right corner of the phone can also be used to indicate when you have a call alerting your phone. The lamp is flashed to indicate a call waiting to be answered.

### Procedure

1. Press the **≡** button.
2. Use the cursor keys to select **Settings**.
3. Use the cursor keys to select **Phone**.
4. Use the cursor keys to select **Alerting on calls**.
5. Use the cursor keys to select **Beacon LED**.
6. Press **Toggle** to change the setting.
7. When completed, press **Save**.
8. Press **Back/Exit** to exit the menus.

### Related links

[Ringer Controls](#) on page 148

---

## Coverage Ring

If you have any bridged appearance and or call coverage buttons, you can set the type of ringing (coverage ring) that should be used when a call alerts on any of those buttons. The options are to use normal ringing, a single non-repeated ring (abbreviated ring) or no ring. The coverage ring setting is only used if you do not already have a connected call. If you already have a connected call in progress, the shorter of the coverage ring and attention ring settings is used.

- This is a user setting which moves with you if you hot desk another phone.
- This menu is not supported on the J139.

### Procedure

1. Press the **Features** soft key if shown.
  - To do this during a call, press the **PHONE** key and then press **Features**.
2. Use cursor keys to select **Call Settings**.
3. Use the cursor keys to select **Coverage Ring**.
4. Press the **Change** soft key to change the setting.
  - **Ring** - Use normal ringing.
  - **Abbreviated** - Use a single non-repeated ring (abbreviated ring).
  - **Off** - No ring.

### Related links

[Ringer Controls](#) on page 148

---

## Ringer Volume

You can adjust the ringer volume while the phone is idle or while it is ringing.

- You can set the ring volume to zero, the phone displays a  icon but still provides visual alerting.

### Procedure

1. With the phone idle or ringing, use the **+** plus and **-** minus keys to adjust the volume.
2. Once you stop adjusting the volume, the display returns to normal after a few seconds.

### Related links

[Ringer Controls](#) on page 148

---

## Internal Auto-Answer

You can select to have internal calls automatically connected if you are not already on a call. The call is connected after the phone gives a brief tone, using either the phone's speaker or the headset as set by the phone's audio path setting.

This function can be assigned to a feature button configured with the **Auto Answer** action. The button lamp indicates when 'internal auto answer' is on. See [Programmable Feature Buttons](#) on page 167.

### Procedure

1. Press the **Features** soft key if shown.
  - To do this during a call, press the  **PHONE** key and then press **Features**.
2. Use cursor keys to select **Call Settings**.
3. Use the up/down cursor keys to select **Internal Auto-Answer**.
4. To change the setting, press the **Change**.

### Related links

[Ringer Controls](#) on page 148

# Chapter 25: Display Controls

This section covers controls for adjusting the phone's display and the information shown on the display.

## Related links

- [Display Brightness](#) on page 151
- [Display Contrast](#) on page 152
- [Single/Dual Column Display](#) on page 152
- [Last Call Duration Display](#) on page 153
- [Call Timer Display](#) on page 153
- [Display Language](#) on page 154
- [Auto Display Waiting Call](#) on page 155
- [Inactivity Timer \(Auto-Return\)](#) on page 155
- [Background Image](#) on page 156
- [Backlight Timer](#) on page 156
- [Text Size](#) on page 157

---

## Display Brightness

You can adjust the brightness of the phone's displays (except on the J169, see [Display Contrast](#) on page 152).

### Procedure

1. Press the **≡** button.
2. Use the cursor keys to select **Settings**.
3. Use the cursor keys to select **Display**.
  - Select the display that you want to adjust. For example, on a phone with button modules attached, several displays may be listed.
4. Use the cursor keys to select **Contrast**.
5. Use the left/right cursor keys to adjust the brightness.
6. When completed, press **Save**.
7. Press **Back/Exit** to exit the menus.

## Related links

[Display Controls](#) on page 151

---

# Display Contrast

On the J169 phone, you can change the display contrast. If the phone also has any button module's attached, you can separated adjust the contrast of the display on each module.

## Procedure

1. Press the **≡** button.
2. Use the cursor keys to select **Settings**.
3. Use the cursor keys to select **Display**.
4. Use the cursor keys to select **Contrast**.
5. Use the left/right cursor keys to adjust the contrast as required.
6. If your phone has button modules, scroll up or down to select the module for which you want to adjust the contrast.
7. When completed, press **Save**.
8. Press **Back/Exit** to exit the menus.

## Related links

[Display Controls](#) on page 151

---

# Single/Dual Column Display

The phone can be set to use either the full screen width (single-column mode) or just a half-width (dual-column mode) for each programmable appearance and feature button. The number of programmable buttons that can be configured is not affected by the selected display mode.

Your system administrator can select which option is used by default. However, you can then select which one you prefer.

In the J159 and J189 phones, this setting only affects the primary screen.

## Procedure

1. Press the **Features** soft key if shown.
  - To do this during a call, press the **PHONE** key and then press **Features**.
2. Use the cursor keys to select **Phone User**.
3. Use the cursor keys to select **Phone Screen Settings**.



4. Use the up and down cursor keys to highlight **Display Mode**.
5. Press the **Change** soft key to change the setting or use the left or right cursor keys.
  - **Dual Column** – Each programmed button occupies one half of the screen line on which it is displayed, either the right-hand or left-hand side. The adjacent physical button on that side of the display is used to indicate the button's status and to control the button feature.
  - **Single Column** – Each programmed button feature occupies the full width of the screen. The physical buttons on both sides of the display are used to control the button feature. However, the button status is only shown by the left-hand button. In this mode, appearance button labels also show a call status icon (for example: idle, alerting, connected).
6. Press **Save**.

#### Related links

[Display Controls](#) on page 151

---

## Last Call Duration Display

As an alternate to call timer display, you can have the phone briefly (4 seconds) display the duration of the call after it is ended.

#### Procedure

1. Press the **Features** soft key if shown.
  - To do this during a call, press the  **PHONE** key and then press **Features**.
2. Use cursor keys to select **Call Settings**.
3. Use the up and down cursor keys to highlight **Show Last Call Duration**.
4. Press the **Change** button to select **On** or **Off**.
5. Press **Save**.

#### Related links

[Display Controls](#) on page 151

---

## Call Timer Display

When you have calls alerting on appearance buttons, the phone can include a timer in the appearance details shown on the display.

- The timer shows how long the call has been alerting.

- When you answer the call, it resets to show how long the call has been connected.
- The timer also shows how long a call has been on hold when you hold the call.

You can turn the timer display on or off. Turning it off provides more space for other call details on the display.

### Procedure

1. Press the **Features** soft key if shown.
  - To do this during a call, press the  **PHONE** key and then press **Features**.
2. Use cursor keys to select **Call Settings**.
3. Use the up/down cursor keys to select **Call Timer**.
4. Press the **Change** button to select **On** or **Off**.
5. Press **Save**.

### Related links

[Display Controls](#) on page 151

---

## Display Language

The system administrator can configure which languages are available for use by the phone for its own menus. Up to five languages can be made available.

Through the phone's menu you can select which of those languages the phone should use.

Note that many of the messages displayed on the phone use text sent from the telephone system. They use the default language of the telephone system unless the system administrator has set your extension to use a specific language supported by the phone system.

### Procedure

1. Press the **≡** button.
2. Use the cursor keys to select **Settings**.
3. Use the cursor keys to select **Display**.
4. Use the **Language**.
5. Use the scroll through the different languages available.
6. To select the currently highlighted language, press **Select**.
7. When completed, press **Save**.
8. Press **Back/Exit** to exit the menus.

### Related links

[Display Controls](#) on page 151

---

## Auto Display Waiting Call

By default, when you are connected on a call, the phone shows details of that call and soft key actions you can perform for that call. In order to see details of a waiting call, you need to scroll the display using the up and down cursor buttons.

You can opt to have the phone automatically show details of a waiting call when one alerts the phone and soft key actions that you can perform on the waiting call. If you use the scroll keys to return the display focus to the currently connected call, the focus automatically returns to the waiting call after a few seconds.

### Procedure

1. Press the **Features** soft key if shown.
  - To do this during a call, press the  **PHONE** key and then press **Features**.
2. Use cursor keys to select **Call Settings**.
3. Use the up and down cursor keys to highlight **Auto Display Waiting Call**.
4. Press the **Change** button to select **On** or **Off**.
5. Press **Save**.

### Related links

[Display Controls](#) on page 151

---

## Inactivity Timer (Auto-Return)

You can set a timer to return the phone to its normal call display after a set period of phone inactivity.

Note that this timer is not applied to the  and **Visual Voice** menus. However, the phone automatically exits the **Visual Voice** menu after 10 minutes if idle.

### Procedure

1. Press the **Features** soft key if shown.
  - To do this during a call, press the  **PHONE** key and then press **Features**.
2. Use the cursor keys to select **Phone User**.
3. Use the cursor keys to select **Phone Screen Settings**.
4. Use the up and down cursor keys to highlight **Auto Return**.
5. Press the **Change** soft key to change the setting or use the left or right cursor keys.
  - **Disabled** - Do not use the inactivity timer.
  - **30/60** - Apply the inactivity timer after the selected number of seconds.

6. Press **Save**.

#### Related links

[Display Controls](#) on page 151

---

## Background Image

The phone has a set of images from which you can select one to use as your background. This setting also controls the background image on any attached JEM24 modules but not that on JBM24 button modules.

#### Procedure

1. Press the **≡** button.
2. Use the cursor keys to select **Settings**.
3. Use the cursor keys to select **Display**.
  - Select the display that you want to adjust. For example, on a phone with button modules attached, several displays may be listed.
4. Use the cursor keys to select **Background**.
5. The list of options is displayed with a highlighted icon next to the currently selected one.
6. Use the cursor keys to change which one is highlighted.
  - To view the highlighted one, press **Preview**. Press **Dismiss** to return to the list.
  - To select the highlighted choice, press **Select**.
7. When completed, press **Save**.
8. Press **Back/Exit** to exit the menus.

#### Related links

[Display Controls](#) on page 151

---

## Backlight Timer

This setting can be used to turn the phone's screen off after a set period of not being used.

#### Procedure

1. Press the **≡** button.
2. Use the cursor keys to select **Settings**.
3. Use the cursor keys to select **Display**.

4. Use the cursor keys to select **Backlight timer**.
5. Enter the time in minutes.
  - Use the **Bksp** soft key to delete any existing value.
  - Setting the value to 0 disables this feature.
  - Setting this feature to a lower value than the screen saver overrides the screen saver.
6. When completed, press **Save**.
7. Press **Back/Exit** to exit the menus.

#### Related links

[Display Controls](#) on page 151

---

## Text Size

You can change the size of the text used on the phone's main display if required. This setting also controls the text size on any attached JEM24 modules but not that on JBM24 button modules.

#### Procedure

1. Press the **≡** button.
2. Use the cursor keys to select **Settings**.
3. Use the cursor keys to select **Display**.
  - Select the display that you want to adjust. For example, on a phone with button modules attached, several displays may be listed.
4. Use the cursor keys to select **Text size**.
5. Use the left/right cursor keys to change the text size.
6. When completed, press **Save**.
7. Press **Back/Exit** to exit the menus.

#### Related links

[Display Controls](#) on page 151

# Chapter 26: Screen Saver

When not being used, the phone can display an image. You can select the image used and how long the phone is idle before the image is shown.

## Related links

[Selecting the Screen Saver](#) on page 158

[Manually Activating the Screen Saver](#) on page 159

[Setting the Screen Saver Timeout](#) on page 159

[Show the Clock on the Screen Saver](#) on page 159

---

## Selecting the Screen Saver

The phone has a set of images from which you can select your screen saver.

### Procedure

1. Press the **≡** button.
2. Use the cursor keys to select **Settings**.
3. Use the cursor keys to select **Display**.
  - Select the display that you want to adjust. For example, on a phone with button modules attached, several displays may be listed.
4. Use the cursor keys to select **Screensaver**.
5. The list of options is displayed with a highlighted icon next to the currently selected one.
6. Use the cursor keys to change which one is highlighted.
  - To view the highlighted one, press **Preview**. Press **Dismiss** to return to the list.
  - To select the highlighted choice, press **Select**.
7. When completed, press **Save**.
8. Press **Back/Exit** to exit the menus.

## Related links

[Screen Saver](#) on page 158

---

## Manually Activating the Screen Saver

Rather than waiting, you can activate the screen save immediately.

### Procedure

1. Press the **≡** button.
2. Use the cursor keys to select **Applications**.
3. Use the cursor keys to select **Activate Screen Saver**.

### Related links

[Screen Saver](#) on page 158

---

## Setting the Screen Saver Timeout

You can set how long the phone is idle before the screen saver is started.

### Procedure

1. Press the **≡** button.
2. Use the cursor keys to select **Settings**.
3. Use the cursor keys to select **Display**.
4. Use the cursor keys to select **Screensaver details**.
5. Use the cursor keys to select **Timer (min)**.
6. Use the **+** and **-** soft keys to increase or decrease the current setting.
  - Setting the value to 0 disables the screen saver.
  - The screen saver is overridden if the backlight timer is set to a lower value.
7. When completed, press **Save**.
8. Press **Back/Exit** to exit the menus.

### Related links

[Screen Saver](#) on page 158

---

## Show the Clock on the Screen Saver

You can select whether the phone should display the time and date at the top of the display whilst the screen saver is active.

On the J159 and J189, when the screen saver is active, the clock, if enabled, only appears on the phone's primary screen.

## Procedure

1. Press the **≡** button.
2. Use the cursor keys to select **Settings**.
3. Use the cursor keys to select **Display**.
4. Use the cursor keys to select **Screensaver details**.
5. Use the cursor keys to select **Clock**.
6. Press **Change**
7. When completed, press **Save**.
8. Press **Back/Exit** to exit the menus.

## Related links

[Screen Saver](#) on page 158



# Chapter 27: Volume and Sound

This section covers controls that relate to volume and to the various sounds that your phone uses. These are in addition to the available ringer controls.

## Related links

- [Button Clicks](#) on page 161
- [Error Tones](#) on page 162
- [Ringer Volume](#) on page 162
- [Handset Volume](#) on page 162
- [Handset Profile](#) on page 163
- [Headset Volume](#) on page 163
- [Headset Profile](#) on page 164
- [Speaker Volume](#) on page 165
- [Automatic Gain Control](#) on page 165
- [Default Handsfree Audio Path](#) on page 165

---

## Button Clicks

While using the phone menus, the phone can provide a key press confirmation click sound. This can be disabled.

### Procedure

1. Press the **≡** button.
2. Use the cursor keys to select **Settings**.
3. Use the cursor keys to select **Audio**.
4. Use the cursor keys to select **Button clicks**.
5. When completed, press **Save**.
6. Press **Back/Exit** to exit the menus.

## Related links

- [Volume and Sound](#) on page 161

## Error Tones

The phone provides an error tone when you make an invalid selection. You can disable the error tone if required.

### Procedure

1. Press the **≡** button.
2. Use the cursor keys to select **Settings**.
3. Use the cursor keys to select **Audio**.
4. Use the cursor keys to select **Error tones**.
5. When completed, press **Save**.
6. Press **Back/Exit** to exit the menus.

### Related links

[Volume and Sound](#) on page 161

---

## Ringer Volume

You can adjust the ringer volume while the phone is idle or while it is ringing.

- You can set the ring volume to zero, the phone displays a  icon but still provides visual alerting.

### Procedure

1. With the phone idle or ringing, use the **+** plus and **-** minus keys to adjust the volume.
2. Once you stop adjusting the volume, the display returns to normal after a few seconds.

### Related links

[Volume and Sound](#) on page 161

---

## Handset Volume

Whilst talking, you can adjust the volume of the incoming call. The volume is adjusted separately for whichever device is in use (handset, headset or speaker).

### Procedure

1. With the call connected, use the **+** plus and **-** minus keys to adjust the volume.
2. The display returns to normal after a few seconds.

**Related links**

[Volume and Sound](#) on page 161

---

## Handset Profile

The default handset can be replaced by alternate handsets, for example an amplified handset or a hearing aid compatible handset. When this is done, the phone's handset profile setting should be changed to ensure optimal audio performance.

**Procedure**

1. Press the **≡** button.
2. Use the cursor keys to select **Settings**.
3. Use the cursor keys to select **Audio**.
4. Use the cursor keys to select **Handset profile**.
5. Use the cursor keys to select the required profile.
6. When completed, press **Save**.
7. Press **Back/Exit** to exit the menus.

**Related links**

[Volume and Sound](#) on page 161

---

## Headset Volume

While talking via the headset, you can adjust the volume of the caller.

**Procedure**

1. Use the **+** plus and **-** minus keys to adjust the volume.
2. Once you stop adjusting the volume, the display returns to normal after a few seconds.
  - If you set the volume to zero (off), the phone displays a  icon.

**Related links**

[Volume and Sound](#) on page 161

## Headset Profile

The phone supports headsets from a range of suppliers. For optimal sound and performance, the phone's headset profile setting may need to be changed to match the headset.

The following is a list of the headsets tested and supported by Avaya and their matching profile setting. Other headsets may also work but have not been tested by Avaya.

Profile	Headsets
1	• Default
2	• <b>Plantronics:</b> SupraPlus Wideband HW251N/HW261N (HIS). • <b>Sennheiser:</b> SH330, SH350, CC510, CC550 (CAVA-31).
3	• <b>Plantronics:</b> EncorePro HW291N/HW301N (HIS). • <b>Sennheiser:</b> Circle SC230/260 (CAVA-31).
4	• <b>Jabra:</b> BIZ 2400 (GN1216). • <b>Sennheiser:</b> Century SC630/660 (CAVA-31). • <b>VXI:</b> CC Pro 4010V DD, CC Pro 4021V DC (OmniCord-V).
5	• <b>Jabra:</b> GN2000 (GN1216).
6	• <b>Jabra:</b> PRO 9470 (14201-33).
7	• <b>Plantronics:</b> CS500 Series CS510, CS520, CS530, CS540 (APV-63). Savi 700 Series - W710, W720, W730, W740, W745 (APV-63).
8	• <b>Sennheiser:</b> DW Pro1, DW Pro2, DW Office, SD Pro1, SD Pro2, SD Office (CEHS-AV03/AV04).

### Procedure

1. Press the **≡** button.
2. Use the cursor keys to select **Settings**.
3. Use the cursor keys to select **Audio**.
4. Use the cursor keys to select **Headset profile**.
5. Select the profile required.
6. When completed, press **Save**.
7. Press **Back/Exit** to exit the menus.

### Related links

[Volume and Sound](#) on page 161

---

## Speaker Volume

While talking via the speaker, you can adjust the volume of the caller.

### Procedure

1. Use the + plus and – minus keys to adjust the volume.
2. Once you stop adjusting the volume, the display returns to normal after a few seconds.
  - If you set the volume to zero (off), the phone displays a  icon.

### Related links

[Volume and Sound](#) on page 161

---

## Automatic Gain Control

When using automatic gain control (AGC), the phone tries to maintain a constant audio level even if the incoming call changes between loud and quiet.

### Procedure

1. Press the  button.
2. Use the cursor keys to select **Settings**.
3. Use the cursor keys to select **Audio**.
4. Use the cursor keys to select **Automatic gain control**.
5. Use the cursor keys to switch between **Handset**, **Headset**, or **Speaker**.
6. To change the highlighted setting, press **Toggle**.
7. When completed, press **Save**.
8. Press **Back/Exit** to exit the menus.

### Related links

[Volume and Sound](#) on page 161

---

## Default Handsfree Audio Path

By default, when you make a call or answer a call without lifting the handset, the audio is played through the phone's speaker while you speak via the phone's microphone.

If you have a headset attached, you can change the phone's behavior so that the audio is played through the headset by default rather than the speaker.

## Procedure

1. Press the **≡** button.
2. Use the cursor keys to select **Settings**.
3. Use the cursor keys to select **Audio**.
4. Use the up and down cursor keys to highlight **Audio path**.
5. Use the left and right cursor keys to switch between **Headset** or **Speaker**.
6. When completed, press **Save**.
7. Press **Back/Exit** to exit the menus.

## Related links

[Volume and Sound](#) on page 161

# Chapter 28: Programmable Feature Buttons

Those programmable buttons not assigned as appearance buttons by your administrator can be used for a range of other features. Those other features can be programmed by you or by your system administrator.

- Your administrator can restrict which buttons you can change.
- This guide only covers those features that you may be able to assign through the phone's own menus. Your administrator has access to a larger range of button functions.
- The use of the button lamps depends on the feature assigned to the button.
- Buttons programmed with a feature that is not supported by the phone, display as **Invalid**.
- This menu is not supported on the J139.

## Related links

[Editing Your Programmable Buttons](#) on page 167

[Programmable Button Features](#) on page 168

---

## Editing Your Programmable Buttons

Self-administration is used to select and apply a function to a feature key. It can be used to replace or delete existing functions.

### Procedure

1. Press the **Features** soft key if shown.
  - To do this during a call, press the  **PHONE** key and then press **Features**.
2. Use the cursor keys to select **Phone User**.
3. Use the cursor keys to select **Self-Administer**.
4. Enter your security PIN and press **Done**.
5. Use the cursor keys to scroll through the list of current functions assigned to each button.
  - To remove the existing function from a button press **Erase**.
  - You can also press **More** and use the **Copy** and **Paste** options to copy the settings of an existing button to another button.

- To assign a function to the highlighted button press **Replace**.
    - Select the required function from the list and press **Select**.
    - Depending on the function, you may need to enter some information such as a target extension number.
  - The button is given a default label based on the function assigned. To change the label, press **More** and then select **Label**. Use the keyboard to enter the text you want to display for the button label. Note that the label is only shown while editing the label and after you exit the administration menu.
6. When completed, press **Back**.

#### Related links

[Programmable Feature Buttons](#) on page 167

---

## Programmable Button Features

There are a wide range of features that can be assigned to the buttons. This guide only lists those that you can assign to a button using the self-administer menu. Features that can only be assigned by your system administrator will be explained by them.

Some actions are not supported on all phones. However, they may be set for users who hot desk between different types of phone.

#### Related links

[Programmable Feature Buttons](#) on page 167

[Abbreviated Dial Button](#) on page 169

[Absence Text Button](#) on page 169

[Account Code Button](#) on page 169

[Auto Answer Button](#) on page 169

[Call Forward All Button](#) on page 170

[Call Park Button](#) on page 170

[Call Park to Other Button](#) on page 170

[Call Pickup Button](#) on page 171

[Call Pickup Any Button](#) on page 171

[Conf Meet Me Button](#) on page 171

[Drop Button](#) on page 171

[Flash Hook Button](#) on page 172

[Group Button](#) on page 172

[Page Button](#) on page 172

[Park and Page Button](#) on page 172

[Ringer Off Button](#) on page 172

[Self-Administer Button](#) on page 173



[Send All Calls Button](#) on page 173

[Suppress Digits Button](#) on page 173

[Twinning Button](#) on page 173

[User Button](#) on page 174

---

## Abbreviated Dial Button

This action can be used as a speed dial button. While setting up the button, enter the number you would like it to dial.

You can enter a partial number and complete the dialing after pressing the button. For example, you can pre-program a button with a particular international dialing code.

### Related links

[Programmable Button Features](#) on page 168

---

## Absence Text Button

Set or clear an absence text message for display on your phone. This text also appears on the display of the phone making the incoming call. When setting the message, you can select from a number of pre-configured messages and then add your own text if you want.

### Related links

[Programmable Button Features](#) on page 168

---

## Account Code Button

This action can be set with or without an account code.

- If the button is set with an account code, that account code is applied to the current call when the button is pressed.
- If the button is set without an account code, pressing the button displays the enter account code menu. See [Manual Account Code Entry](#) on page 122.

### Related links

[Programmable Button Features](#) on page 168

---

## Auto Answer Button

A button configured with this action can be used to switch 'internal auto-answer' on or off. When 'internal auto-answer' is on, the button's red lamp is lit. Pressing the button again turns 'internal auto-answer' off.

This type of button is not supported on J139 phones.

#### Related links

[Programmable Button Features](#) on page 168

---

## Call Forward All Button

A button with this action can be used to switch 'forwarding unconditional' on/off.

- If set with a preset number, that number is used as the forwarding destination.
- If set without a number, when the button is pressed you are asked to confirm your existing 'forward unconditional' destination number or to enter a new number.

The button's red lamp is lit when forwarding is enabled.

#### Related links

[Programmable Button Features](#) on page 168

---

## Call Park Button

A button set to this action can be used to park and unpark calls. The button can be set with or without a park slot number.

- When associated with a specific park slot number, the button can park and unpark a call from that park slot. When a call has been parked in that park slot, the button's lamp flashes. Green if the call was parked using that button, red if parked by another method. Pressing the button again retrieves the call.
- When not associated with a specific park slot number:
  - If pressed while you have a call connected, that call is parked using a park slot number assigned by the system based on your extension number.
  - If pressed while you have no call connected, your phone displays details of your parked calls and allow you to unpark a selected call.
  - When you have calls that you parked (other than Park & Page) or others parked against your extension, the button's lamp flashes.

#### Related links

[Programmable Button Features](#) on page 168

---

## Call Park to Other Button

A button set with this action can be used to park a call against another extension. The park slot number used is based on your extension number.

The button can be set with a target user number or left blank for number entry when the button is pressed. The button's red lamp is lit when a call is parked. The button can be pressed again to retrieve the call.

**Related links**

[Programmable Button Features](#) on page 168

---

## Call Pickup Button

Answer a call ringing a user or hunt group.

The target user or group number from which to pickup a call can be set when the button is configured. If no number is set, pressing the button displays a menu for number entry.

**Related links**

[Programmable Button Features](#) on page 168

---

## Call Pickup Any Button

Answer a call currently ringing on the telephone system.

**Related links**

[Programmable Button Features](#) on page 168

---

## Conf Meet Me Button

A button programmed to this feature allows you to start or enter a conference by entering the conference ID.

This type of button is not supported on J139 phones.

**Related links**

[Programmable Button Features](#) on page 168

---

## Drop Button

This action can be used to drop your current call without having to highlight it on the display. If the call is connected, pressing the key ends the call. If the call is ringing it may follow several routes. See [Dropping an Incoming Call](#) on page 50.

**Related links**

[Programmable Button Features](#) on page 168

## Flash Hook Button

A button configured for this action sends a flash hook signal to a currently connected analog line.

### Related links

[Programmable Button Features](#) on page 168

---

## Group Button

A button can be programmed to indicate if there are any calls to a group waiting to be answered. A red flashing lamp indicates that there are calls waiting for the hunt group. Press the button to pickup the longest waiting call.

### Related links

[Programmable Button Features](#) on page 168

---

## Page Button

A button configured with this action can be used to make a page call.

The button can be configured with the target user or group for the page. If configured without a number, pressing the button displays a menu for number entry before making the page call.

### Related links

[Programmable Button Features](#) on page 168

---

## Park and Page Button

If your system administrator has configured your system for Park & Page, this button allows you to use the feature to park calls and announce the parked call to other users.

### Related links

[Programmable Button Features](#) on page 168

---

## Ringer Off Button

A button configured with this action can be used to turn your phone's ringer on or off.

When you turn the ringer off, visual alerting is also turned off. When the ringer has been turned off, the button's red lamp is lit. Pressing the button again turns the ringer on.

**Related links**

[Programmable Button Features](#) on page 168

---

## Self-Administer Button

A button configured for this action can be used to access the Self Administer menu.

This type of button is not supported on J139 phones.

**Related links**

[Programmable Button Features](#) on page 168

---

## Send All Calls Button

A button configured with this action can be used to switch 'do not disturb' on or off. When 'do not disturb' is on, the button's red lamp is lit or a red warning icon is displayed. Pressing the button again turns 'do not disturb' off.

**Related links**

[Programmable Button Features](#) on page 168

---

## Suppress Digits Button

Masks the display of digits as you dial them on the phone. Dialed digits are replaced with an **s** character. The button is used to switch the suppression on/off. When 'suppress digits' has been set, the button's red lamp is lit. Pressing the button again cancels the suppression.

- If en-bloc dialing is active you still see the digits as you dial them. When you make the call the digits are suppressed.
- When the option to suppress digits is used, the call is not recorded in the call log.

**Related links**

[Programmable Button Features](#) on page 168

---

## Twining Button

A button configured for this feature allows you to control your phone's mobile twinning operation.

[Twining](#) on page 89

This is only usable if your system administrator has configured you for mobile twinning.

- If pressed when the phone is idle, the phone displays the mobile twinning menu. You can use the menu to switch mobile twinning on/off and to setting the twinned destination.

- If pressed while a twinned call is connected to the twinned destination, the system attempts to reclaim the call.
- If pressed while connected to a call on the phone, the system attempts to transfer the call to the twinned destination. You do not need twinning switched on to use this feature.

**Related links**

[Programmable Button Features](#) on page 168

---

## User Button

This type of button monitors the status of another user. The button lamp indicates the status of the user.

- **Off = Available** – Pressing the button makes a call to the user. In addition to calling the user, you can use the user button to transfer calls to the user or to start a conference with the user.
- **Slow Flash = Ringing** – Pressing the button display options to pickup the call.
- **Fast Flash = On a Call** – Pressing the button display the following options:
  - **Call** – Call the user.
  - **Message** – Cause a single burst of ringing on the user's phone. They also see the message "**Please Call**" followed by your extension number.
  - **Voicemail** – Call the user's voicemail mailbox to leave a message.
  - **CallBack** – Set an automatic callback on the user. The callback occurs when the user ends their current call.

The following options are only available if configured for you by your system administrator:

- **Drop** – Disconnect the user's current call.
- **Acquire** – Seize the user's current call.
- **Intrude** – Join the user's current call, turning it into a conference call.
- **Listen** – Start silent monitoring of the user's call.

**Related links**

[Programmable Button Features](#) on page 168

# Part 8: Miscellaneous

# Chapter 29: Short Codes

Short codes are numbers that you can dial to enable and disable various features. The following are default short codes that may be available. However, your system administrator can remove and change the short codes available to you or all users. To use a short code, you may have to put your currently call on hold.

These are useful as they can be dialed from any phone on the system. For example, this allows you to login at a basic analog extension and still control a number of features.

Some short codes require you to enter some information when you dial them, typically an extension number. That is indicated by **N** in the short codes shown below.

## Park/Unpark

- **Park Call: \*37\*N#** – Parks the held call using the park number dialed in place of **N**.
- **Unpark Call: \*38\*N#** – Unpark the call parked using the park number **N**.

## Call Pickup

- **Pickup Any Call: \*30** – Answer a call ringing on the telephone system.
- **Pickup a Group Call: \*31** – Answer a call ringing a group of which you are a member. You can use this even if your group membership is currently set to disabled.
- **Pickup a Users Call: \*32\*N#** – Pickup a call ringing a user's extension number (**N**).
- **Pickup a Group Members Call: \*53\*N#** – Pickup a call ringing the members of a group (**N**). This does not necessarily have to be a group call.

## Conference

- **Conference Held Calls: \*47** – Start a conference between yourself and any calls that you have on hold.

## Do Not Disturb

- **Switch Do Not Disturb On: \*08** – Set your phone to 'do not disturb.'
- **Switch Do Not Disturb Off: \*09** – Switch off 'do not disturb.'
- **Add a Do Not Disturb Exception Number: \*10\*N#** – Add a number (**N**) to your list of 'do not disturb' exceptions.
- **Delete a Do Not Disturb Exception Number: \*11\*N#** – Remove a number (**N**) from your list of 'do not disturb' exceptions.
- **Cancel All Forwarding: \*00** – Switch off any forwarding (includes 'forward unconditional,' 'forward on busy,' 'forward on no answer,' 'follow me,' and 'do not disturb').



## Follow Me

- **Follow Me Here: \*12\*N#** – Dialed at the extension to which you want your calls redirected. Use your own extension number (**N**) when dialing the short code.
- **Follow Me Here Cancel: \*13\*N#** – Dialed at the extension from which you had redirected calls. Use your own extension number (**N**) when dialing the short code.
- **Follow Me To: \*14\*N#** – Dialed at your phone. Dial the extension number (**N**) to which you want your calls redirected. You can dial just **\*14#** to cancel follow me.
- **Cancel All Forwarding: \*00** – Switch off any forwarding (includes 'forward unconditional,' 'forward on busy,' 'forward on no answer,' 'follow me,' and 'do not disturb').

## Forwarding

- **Forward Unconditional:**
  - **Set the Forward Unconditional Destination: \*07\*N#** – Set the destination number (**N**) for 'forward unconditional' when it is switched on.
  - **Switch Forward Unconditional On: \*01** – Switch on 'forward unconditional.' A destination must have been set.
  - **Switch Forward Unconditional Off: \*02**
  - **Include Hunt Group Calls in Forward Unconditional: \*50**
  - **Exclude Hunt Group Calls from Forward Unconditional: \*51**
- **Forward on Busy/No Answer:**
  - **Set the Forward On Busy/No Answer Destination: \*57\*N#** – Set the destination number (**N**) for 'forward on busy' and 'forward on no answer.' If no number has been set, those functions use the 'forward unconditional' number if set.
  - **Switch Forward On Busy On: \*03**
  - **Switch Forward On Busy Off: \*04**
  - **Switch Forward on No Answer On: \*05**
  - **Switch Forward on No Answer Off: \*06**
- **Cancel All Forwarding: \*00** – Switch off any forwarding (includes 'forward unconditional,' 'forward on busy,' 'forward on no answer,' 'follow me,' and 'do not disturb').

## Hunt Group

- **Night Service Status On: \*20\*N#** – Set a hunt group into night service status by entering its extension number (**N**).
- **Night Service Status Off: \*21\*N#** – Take a hunt group out of night service status by entering its extension number (**N**).

## Login

- **Log In: \*35\*N\*P#** – Log in to a phone using your extension number (**N**) and login code (**P**).
- **Log Out: \*36** – Log yourself out from the phone where you are currently logged in.

## Voicemail

- **Check Messages: \*17** – Access mailboxes to check for messages.

- **Voicemail On: \*18** – Allow voicemail to be used to answer calls.
- **Voicemail Off: \*19** – Stop voicemail being used to answer calls.
- **Voicemail Ringback On: \*48** – Have voicemail ring your phone when you have any new messages. It rings after you next use the phone.
- **Voicemail Ringback Off: \*49** – Switch off ringback.

# Chapter 30: System Administration

If necessary, the system administrator can configure you as a system phone user. This allows you to perform a range of additional functions to help maintain your phone system.

These functions are not supported by the J139.

## Related links

[Checking the System Information](#) on page 179

[Checking the Time Server Status](#) on page 180

[Setting the Date](#) on page 180

[Setting the Time](#) on page 181

[Setting the Time Offset](#) on page 182

[Restarting the System](#) on page 183

[Managing the Memory Cards](#) on page 184

[Reporting System Alarms](#) on page 185

---

## Checking the System Information

Being able to check and report the system name, software version and IP address may be useful when reporting any potential problems to the system maintainer.

### Procedure

1. Press the **Features** soft key if shown.
  - To do this during a call, press the  **PHONE** key and then press **Features**.
2. Use the cursor keys to select **Phone User**.
3. Use the cursor keys to select **System Administration**.
  - This option is only present if you have been configured as a system phone user by your system administrator.
  - This menu is not supported on J139 phones.
4. Enter your security PIN (login code) and press **Done**.
5. Use the cursor keys to select **System Information**.
6. The system displays information about itself.

## Related links

[System Administration](#) on page 179

---

# Checking the Time Server Status

For systems that automatically obtain the time from a time server, this option allows you to check the current status of the time server and the information obtained from it.

## Procedure

1. Press the **Features** soft key if shown.
  - To do this during a call, press the  **PHONE** key and then press **Features**.
2. Use the cursor keys to select **Phone User**.
3. Use the cursor keys to select **System Administration**.
  - This option is only present if you have been configured as a system phone user by your system administrator.
  - This menu is not supported on J139 phones.
4. Enter your security PIN (login code) and press **Done**.
5. Use the cursor keys to select **Time Server Status**.
6. The time server information is listed. It includes the address of the time server, the current local time and the UTC time. If the phone system is configured for daylight savings then the current amount of daylight savings being applied to the local time is also shown.

## Related links

[System Administration](#) on page 179

---

# Setting the Date

The process below can be used when the telephone system does not obtain the time and date automatically. On systems that are configured to obtain the time automatically, the option for checking the **Time Server Status** is available instead. See [Checking the Time Server Status](#) on page 180.

## Procedure

1. Press the **Features** soft key if shown.
  - To do this during a call, press the  **PHONE** key and then press **Features**.
2. Use the cursor keys to select **Phone User**.

3. Use the cursor keys to select **System Administration**.
  - This option is only present if you have been configured as a system phone user by your system administrator.
  - This menu is not supported on J139 phones.
4. Enter your security PIN (login code) and press **Done**.
5. Use the cursor keys to select **Date**.
6. The current date being used by the telephone system is displayed.
7. Enter the required date:
  - Use the \* or # keys to enter the / separators.
  - To delete the previous digit or character entered, press **Bksp**.
8. When a valid date has been entered, the display confirms that by showing the **Set** soft key.
9. To set the date as the new date to be used by the telephone system, press **Set**.

#### Related links

[System Administration](#) on page 179

---

## Setting the Time

The process below can be used when the telephone system does not obtain the time and date automatically. On systems that are configured to obtain the time automatically, the option for checking the **Time Server Status** is available instead. See [Checking the Time Server Status](#) on page 180.

- The time display format is controlled by the telephone system. It can be set to either 12-hour or 24-hour format for all phones by your system administrator.

#### Procedure

1. Press the **Features** soft key if shown.
  - To do this during a call, press the  **PHONE** key and then press **Features**.
2. Use the cursor keys to select **Phone User**.
3. Use the cursor keys to select **System Administration**.
  - This option is only present if you have been configured as a system phone user by your system administrator.
  - This menu is not supported on J139 phones.
4. Enter your security PIN (login code) and press **Done**.
5. Use the cursor keys to select **Time**.
6. The current time being used by the telephone system is displayed.

7. Enter the required time in 24-hour clock format:
  - Use either the \* or # keys to enter the : separator.
  - To delete the previous digit or character, press **Bksp**.
8. When a valid time has been entered, the display confirms that by showing the **Set** soft key.
9. To set the time as the new time to be used by the telephone system, press **Set**.

#### Related links

[System Administration](#) on page 179

---

## Setting the Time Offset

The process below can be used when the telephone system does not obtain the time and date automatically. On systems that are configured to obtain the time automatically, the option for checking the **Time Server Status** is available instead. See [Checking the Time Server Status](#) on page 180.

#### Procedure

1. Press the **Features** soft key if shown.
  - To do this during a call, press the  **PHONE** key and then press **Features**.
2. Use the cursor keys to select **Phone User**.
3. Use the cursor keys to select **System Administration**.
  - This option is only present if you have been configured as a system phone user by your system administrator.
  - This menu is not supported on J139 phones.
4. Enter your security PIN (login code) and press **Done**.
5. Use the cursor keys to select **Local Time Offset**.
6. The current offset is displayed.
7. Enter the offset required in hours and minutes:
  - To enter the : separator press either the \* or # key.
  - To delete the previous digit or character entered press the **Bksp** key.
  - To change the offset from between positive or negative press the right cursor key.
8. When a valid offset has been entered, the **Set** soft key is displayed.
9. To apply the offset to the current telephone system time, press the **Set** soft key.

#### Related links

[System Administration](#) on page 179

## Restarting the System

You can shutdown the telephone system for a specified number of minutes.

The telephone system remains unavailable for the duration you specify, the default 10 minutes. After the shutdown duration, there is a further short delay for the telephone system to complete its restart.

### Important:

- A shutdown must always be used to switch off the system. Simply removing the power cord or switching off the power input may cause errors.
- This is not a polite shutdown, any users calls and services in operation are stopped. Once shutdown, the system cannot be used to make or receive any calls until restarted.
- The shutdown process takes up to a minute to complete. When shutdown, the CPU LED and the base card LEDs 1 and 9 (if trunk daughter card fitted) flash red rapidly. The memory card LEDs are extinguished. Do not remove power from the system or remove any of the memory cards until the system is in this state.
- To restart a system when shutdown indefinitely, or to restart a system before the timed restart, switch power to the system off and on again.

### Procedure

1. Press the **Features** soft key if shown.
  - To do this during a call, press the  **PHONE** key and then press **Features**.
2. Use the cursor keys to select **Phone User**.
3. Use the cursor keys to select **System Administration**.
  - This option is only present if you have been configured as a system phone user by your system administrator.
  - This menu is not supported on J139 phones.
4. Enter your security PIN (login code) and press **Done**.
5. Use the cursor keys to select **System Shutdown**.
6. The current default timeout (10 minutes) setting is shown and can be used by pressing **OK** soft key. Otherwise, enter the timeout required in hours and minutes and then press the **Ok** soft key.
  - The allowable range for the timeout is from **00:00** to **24:00**. Note that a timeout of 00:00 indicates infinite (no) timeout.
  - The **OK** soft key is not displayed if the timeout entered is not within the allowed range.
  - To enter the : symbol in the timeout press either the \* or # key.
  - To delete the previous digit or character entered press the left cursor key.
7. After pressing **OK**, you are asked to confirm whether you want to shutdown the system. Only proceed if you are sure. If you are not sure press **Back**.

8. If you press the **Confirm** soft key, the telephone system is shutdown.

### Related links

[System Administration](#) on page 179

---

## Managing the Memory Cards

The telephone system can be fitted with an additional memory card or cards which are used for various functions. The memory card menu allows you to check the status of the memory card or cards fitted to your telephone system and to perform a number of actions on the cards.

### Procedure

1. Press the **Features** soft key if shown.
  - To do this during a call, press the  **PHONE** key and then press **Features**.
2. Use the cursor keys to select **Phone User**.
3. Use the cursor keys to select **System Administration**.
  - This option is only present if you have been configured as a system phone user by your system administrator.
  - This menu is not supported on J139 phones.
4. Enter your security PIN (login code) and press **Done**.
5. Use the up and down cursor keys to scroll the display to the option **Memory Card** (*IP500/ IP500 V2*) or **File System** (*Server Edition*). The option shown varies depending on the type of telephone system.
6. The menu lists the current state of the system's memory cards and the actions that you can perform on the card.
7. The status of each memory card listed is either **No Card**, **Active**, or **Inactive**. Entries are only listed for the types of cards that are supported:
  - **CF** - This refers to the optional compact flash card that can be fitted to IP500 systems.
  - **System** - This refers to the first SD memory card that must be fitted to IP500 V2 systems.
  - **Option** - This refers to the second optional SD memory card that can be fitted to IP500 V2 systems.
8. The actions that can be performed on the memory cards are listed below the status of the card or cards. The actions available depend type of card and its current status. After selecting an action, you can then select the card on which you want the action performed and then press the **Confirm** soft key to start the action.
  - **Shut Down** (*IP500 V2*) – This option is available when an **Active** card is present. It allows the card to be made inactive.



- **Start Up** – This option is available when an **Inactive** card is present. It allows the card to be made active again.
- **System Backup** (*IP500 V2/Server Edition*) – This option is available when a **System** card is present and active. It allows the telephone system's current configuration settings to be copied to a backup file on the memory card.
- **System Restore** – This option is available when a **System** card is present and active. It overwrites the telephone system's current configuration settings with those from a backup file on the card.
- **Upgrade Config** (*IP500 V2*) – Copy configuration files from an **Option** card to the **System** card in the system control unit.
- **Upgrade Binaries** (*IP500 V2*) – Copy software files from an **Option** card to the **System** card in the system control unit.
- **Copy** (*IP500 V2*) – This option is available on systems where both a **System** and **Option** memory card are active. It copies the contents of the **System** card to the **Option** card.

#### Related links

[System Administration](#) on page 179

---

## Reporting System Alarms

An **S** in the phone status letters indicates a system alarm. This happens if you are configured as a system phone user.

Details of the alarm may also appear in your phone's **Status** menu. This allows you to report the problem to your system administrator or maintainer. Note that the alarms vary depending on the type of system.

#### Procedure

1. Press the **≡** button.
2. Scroll to the alarm message text:
  - If displayed, press **Admin** to see additional information.
  - If displayed, press **Clear** to clear the alarm.

#### Related links

[System Administration](#) on page 179

# Chapter 31: The Status Menu

The **Status** menu is not always visible. It is shown when you have any special call routing features active; for example, 'do not disturb' switched on.

It is also shown if the system administrator has given you the rights to change the status of your hunt group memberships or to change the service status of the hunt groups.

## Related links

- [Do Not Disturb](#) on page 186
- [Follow Me To](#) on page 187
- [Follow Me Here](#) on page 187
- [Forward on Busy](#) on page 187
- [Forward on No Answer](#) on page 188
- [Forward Unconditional](#) on page 189
- [Forwarded Here](#) on page 189
- [Group Membership](#) on page 190
- [Group Status](#) on page 190
- [Switch Mobile Twinning Off](#) on page 191
- [Parked Calls](#) on page 191
- [System Alarms](#) on page 192

---

## Do Not Disturb

You can use the **Status** menu to switch off 'do not disturb.'

- Your system administrator can configure whether you can access this menu.

### Procedure

- Press the **Status** soft key if shown.
  - To do this during a call, press the  **PHONE** key and then press the **Status** soft key.
- Use the cursor keys to select **Do Not Disturb**.
- To clear the 'do not disturb' setting, press the **Off** soft key.

## Related links

- [The Status Menu](#) on page 186

---

## Follow Me To

If you have set a 'follow me to' destination for your calls, you can clear or change the setting through your phone's **Status** menu.

### Procedure

1. Press the **Status** soft key if shown.
  - To do this during a call, press the  **PHONE** key and then press the **Status** soft key.
2. Use the up and down cursor keys to highlight **Follow Me To**.
  - To clear the 'follow me to' setting, press the **Clear** soft key.
  - To change the destination of the setting, press the **Details** soft key.

### Related links

[The Status Menu](#) on page 186

---

## Follow Me Here

If other users has a 'follow me' set to your phone, you can clear or change the setting through the **Status** menu.

### Procedure

1. Press the **Status** soft key if shown.
  - To do this during a call, press the  **PHONE** key and then press the **Status** soft key.
2. Use the up and down cursor keys to highlight **Follow Me Here**.
  - To clear the setting, press the **Clear** soft key.
  - To change the destination of the setting, press the **Details** soft key.

### Related links

[The Status Menu](#) on page 186

---

## Forward on Busy

If your phone is set to 'forward on busy' you can clear or change the forward settings through the **Status** menu.

- Your system administrator can configure whether you can access this menu.

## Procedure

1. Press the **Status** soft key if shown.
  - To do this during a call, press the  **PHONE** key and then press the **Status** soft key.
2. Use the cursor keys to select **Forward on No Answer**.
3. To switch forwarding off, press **Off**.
4. To change the setting, press **Details**.
  - To switch 'forward on busy' on or off, highlight **Fwd Busy** and press **On** or **Off**.
  - To switch 'forward on no answer' on or off, highlight **Fwd No Answer** and press **On** or **Off**.
  - To select which calls are forwarded, highlight **Call type**. Press **Change** to change the option between **All Calls** or **External Only**.
  - To change the destination, highlight **Destination** and press **Edit**. Enter the number and press **Select**.
  - Press **Save** to save any changes.

## Related links

[The Status Menu](#) on page 186

---

# Forward on No Answer

If your phone is set to 'forward on no answer' you can clear or change the forward settings through the **Status** menu.

- Your system administrator can configure whether you can access this menu.

## Procedure

1. Press the **Status** soft key if shown.
  - To do this during a call, press the  **PHONE** key and then press the **Status** soft key.
2. Use the cursor keys to select **Forward on No Answer**.
3. To switch forwarding off, press **Off**.
4. To change the setting, press **Details**.
  - To switch 'forward on busy' on or off, highlight **Fwd Busy** and press **On** or **Off**.
  - To switch 'forward on no answer' on or off, highlight **Fwd No Answer** and press **On** or **Off**.
  - To select which calls are forwarded, highlight **Call type**. Press **Change** to change the option between **All Calls** or **External Only**.
  - To change the destination, highlight **Destination** and press **Edit**. Enter the number and press **Select**.

- Press **Save** to save any changes.

**Related links**

[The Status Menu](#) on page 186

---

## Forward Unconditional

You can clear or change your 'forward unconditional' settings through the **Status** menu.

**Procedure**

1. Press the **Status** soft key if shown.
  - To do this during a call, press the  **PHONE** key and then press the **Status** soft key.
2. Use the cursor keys to select **Forward Unconditional**.
  - To switch off forward unconditional, press the **Off** soft key.
  - To change the forwarding settings, press the **Details** soft key.
3. Press **Save**.

**Related links**

[The Status Menu](#) on page 186

---

## Forwarded Here

This option allows you to see the names of users who are currently forwarding calls to you. It includes 'forward unconditional,' 'forward on no answer,' and 'forward on busy.' A separate entry is shown for each user.

**Procedure**

1. Press the **Status** soft key if shown.
  - To do this during a call, press the  **PHONE** key and then press the **Status** soft key.
2. Use the up and down cursor keys to highlight **Fwd To Here**.

**Related links**

[The Status Menu](#) on page 186

---

## Group Membership

Your system administrator can grant you the ability to enable/disable your membership to a group through the Status menu. When your membership to a group is disabled, you do not receive group calls for that group.

- The system administrator is able to configure whether you have access to the **Membership**, **State** and **Fallback** options of a group. If you are not configured for any groups, the **Group** menu is not shown
- This menu is not supported on the J139.

### Procedure

1. Press the **Status** soft key if shown.
  - To do this during a call, press the  **PHONE** key and then press the **Status** soft key.
2. Use the up and down cursor keys to highlight the hunt group name and your current membership status.
3. Press the **Enabled** or **Disabled** soft key to change the status of your membership to that group.
4. Press **Exit**.

### Related links

[The Status Menu](#) on page 186

---

## Group Status

If the system administrator has allowed you, you can change the service state of a group through the **Status** menu.

### Procedure

1. Press the **Status** soft key if shown.
  - To do this during a call, press the  **PHONE** key and then press the **Status** soft key.
2. Use the up and down cursor keys to highlight the hunt group name and your current membership status.
3. Select the required state using the soft keys:
  - **InS (In Service)** – The groups operates as normal, distributing calls to available members of the group.
  - **NS (Night Service)** – The group is in 'night service' mode. Calls are redirected to its night service fallback destination if set, otherwise to voicemail if available. A hunt group can also be put into and out of night service automatically by the telephone system using a time profile.

- **OOS (Out of Service)** – The group is out of service. Calls are redirected to its out of service fallback destination if set, otherwise to voicemail if available. The phone displays an **O** when one of the groups of which you are a member is out of service.
- **TP (Time Profile)** – This setting indicates that the group's status is being controlled by a time profile on the telephone system. That time profile sets when the group is in service and in night service. You can override this to put the group into the **Out of Service** state. You can then use the phone to return the group to time profile control when required.

#### Related links

[The Status Menu](#) on page 186

---

## Switch Mobile Twinning Off

If you have been configured as a mobile twinning user, you can use the status menu to switch mobile twinning mode off.

#### Procedure

1. Press the **Status** soft key if shown.
  - To do this during a call, press the  **PHONE** key and then press the **Status** soft key.
2. Use the up and down cursor keys to highlight **Mobile Twinning**.
  - To clear the setting, press the **Off** soft key.
  - To access the twinning menu instead, press **Details**.

#### Related links

[The Status Menu](#) on page 186

---

## Parked Calls

While parked calls are parked on the telephone system and can be unparked by any other user, the parked call indication is sent to a particular extension. If there are any calls parked against your phone, you can view and unpark them via the **Status** menu.

- Your system administrator can configure whether you can access this menu.
- This menu is not supported on the J139.

#### Procedure

1. Press the **Status** soft key if shown.
  - To do this during a call, press the  **PHONE** key and then press the **Status** soft key.
2. If you have any parked calls, the **Parks...** option is displayed. The option is not present if you do not have calls parked against your extension.

3. Press the **Details** soft key.
4. Use the cursor keys to scroll through the parked calls.
5. To unpark a particular call, highlight it and then press the **Connect** soft key.

**Related links**

[The Status Menu](#) on page 186

---

## System Alarms

An **S** in the phone status letters indicates a system alarm. This happens if you are configured as a system phone user.

Details of the alarm may also appear in your phone's **Status** menu. This allows you to report the problem to your system administrator or maintainer. Note that the alarms vary depending on the type of system.

**Procedure**

1. Press the **≡** button.
2. Scroll to the alarm message text:
  - If displayed, press **Admin** to see additional information.
  - If displayed, press **Clear** to clear the alarm.

**Related links**

[The Status Menu](#) on page 186



# Chapter 32: Menus

This section provides an overview of the menus displayed on the phone. These are only a general indication. The menu options can vary depending on the version of phone firmware and the configuration of the telephone system.

Your system administrator can also restrict the menu options available.

## Related links

[Status Menu](#) on page 193

[Features Menu](#) on page 194

[Main Menu](#) on page 195

[Menu Access Control](#) on page 195

[J139 Restrictions](#) on page 197

---

## Status Menu

This menu is accessed by pressing the **Status** soft key when displayed. The features shown vary depending on the options currently enabled. See [The Status Menu](#) on page 186.

### J159/J169/J179/J189 Status Menu

Mobile Twinning	On
Parks...	
Follow Me To	On
Do Not Disturb	On
Forward Unconditional	On
Forward on No Answer	On
Forward on Busy	On
Follow Me Here...	
Forward Here...	
Main	Enabled
Main	In Service

### J139 Status Menu

Mobile Twinning	On
Follow Me To	On
Do Not Disturb	On
Forward Unconditional	On
Forward on No Answer	On
Forward on Busy	On
Follow Me Here...	
Forward Here...	

**Related links**

[Menus](#) on page 193

# Features Menu

This menu is accessed by pressing the **Features** soft key.

## J159/J169/J179/J189 Features Menu

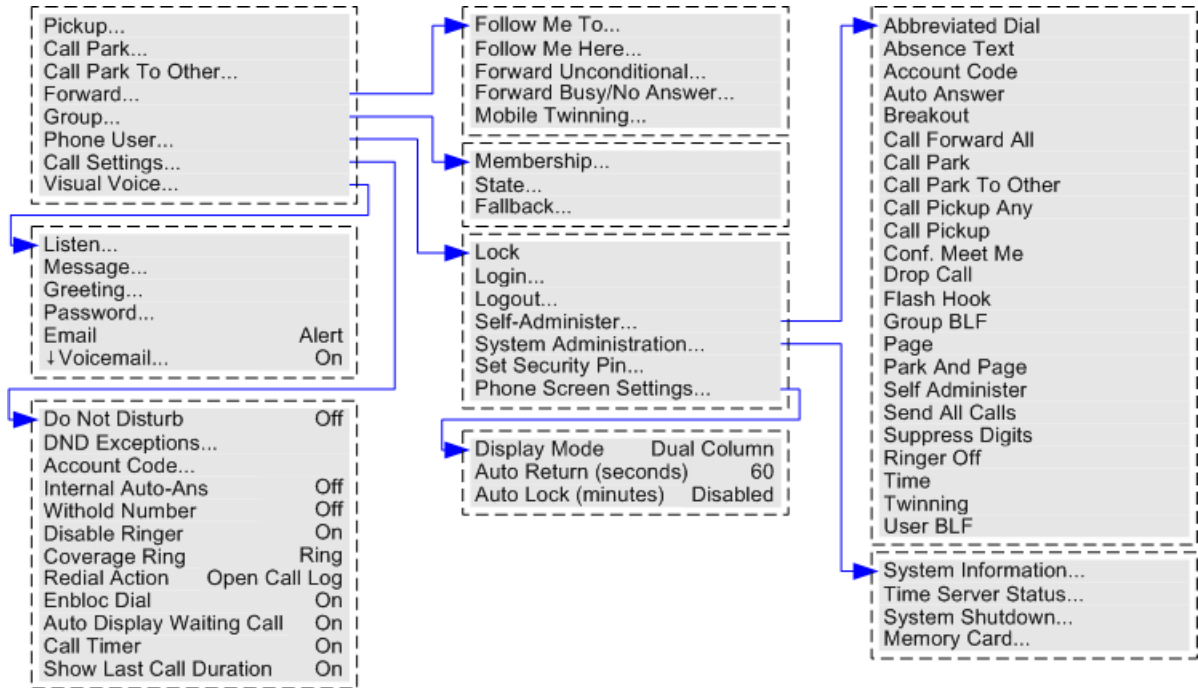

## J139 Features Menu

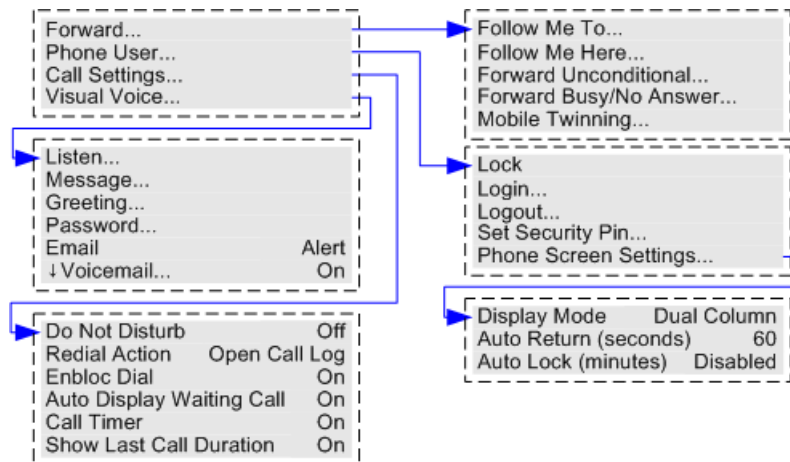

## Related links

[Menus](#) on page 193

# Main Menu

This menu is used mainly for phone specific settings that are stored by the phone rather than settings that are stored by the phone system.

The menu is accessed by pressing the key. On some phones, press the  $\equiv$  key and then select **Settings**. Note that the options available vary between different models of telephone.

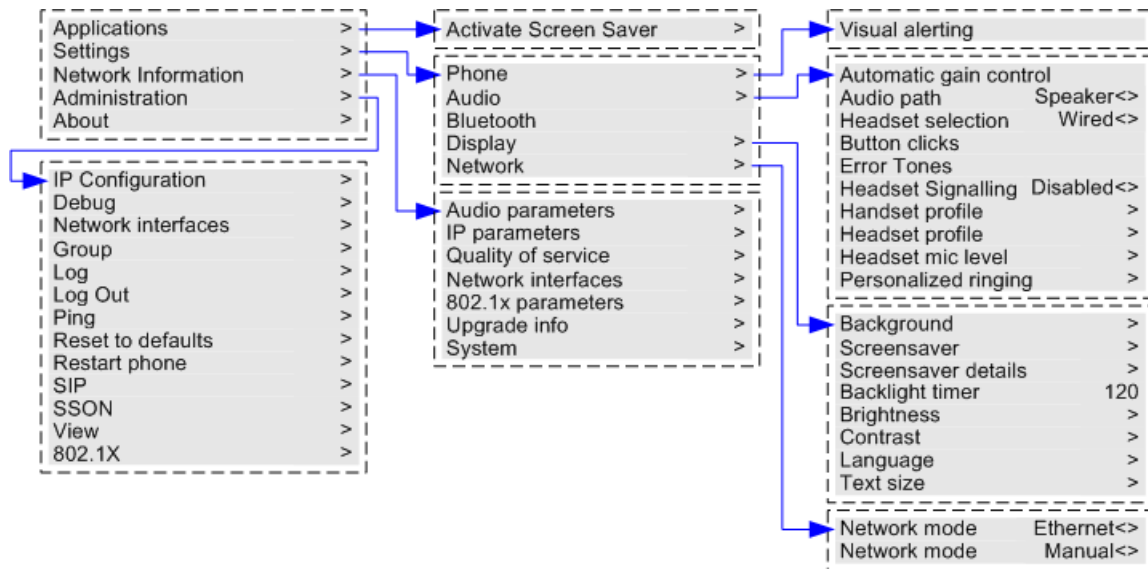

## Related links

[Menus](#) on page 193

# Menu Access Control

Some menu options are dynamic and only appear when appropriate. For example, the **Features** menu cannot be accessed when the phone is locked.

Access to other menu options is controlled by your system administrator:

- They can set system wide rules that apply to all users. They can also set specific rules for individual users.
- If you are restricted from accessing an option, it may still be applied for you by your system administrator. For example, the system administrator may configure call forwarding settings for you.

- The J139 is restricted from accessing some functions regardless of the system administrator's settings, see [J139 Restrictions](#) on page 197.
- Note that restricting menu access does not restrict access using available short codes and programmable buttons. However, those can also be removed or added by your system administrator.

The system administrator can control your menu access to the following groups of functions:

- **Basic Call Functions** – Controls whether you can access the phone's menu options for call pickup, park, unpark and transfer to mobile functions.
- **Advanced Call Functions** – Controls whether you can access the phone's menu options for do not disturb, account code, withhold number and internal auto-answer functions. In addition, the account code menu is only shown if the system has been configured with accounts codes.
  - This menu is not supported on the J139.
- **Forwarding Functions** – Controls whether you can access the phone's menu options for forwarding and follow me functions.
- **Hot Desk Functions** – Controls whether you can access the menu options for logging in and out.
- **Passcode Change** – Controls whether you can change your login code (security credentials).
- **Phone Lock** – Controls whether you can access the menu options for locking the phone and for setting it to automatically lock.
- **Self Administration** – Controls whether you can access the **Self-Administer** menu option.
  - This menu is not supported on the J139.
- **Voicemail Controls** – Controls whether you can access the **Visual Voice** option through the phone's **Features** menu. Your system administrator can also disable the Messages button from accessing the visual voice menus.
- **Group Controls** – The system administrator is able to configure if you can access the Membership, State and Fallback options of a group. If you are not configured for any groups then the Group menu is not shown.
  - This menu is not supported on the J139.
- **Mobility Controls** – The **Mobile Twinning** options are only shown if you have been configured to use mobile twinning.
- **System Administration Controls** – The **System Administration** option is only shown if you have been configured as a 'System Phone' user.
  - This menu is not supported on the J139.

### Related links

[Menus](#) on page 193

## J139 Restrictions

### Menu Support

The J139 uses the same **Feature** and **Status** menus as other J100 Series telephones except for the following menu options. In some cases, the menu feature may still be usable via short codes, a programmable button and/or using an application.

<ul style="list-style-type: none"> <li>• Auto-Answer</li> <li>• Call Pickup</li> <li>• Call Park</li> <li>• Coverage Ring</li> </ul>	<ul style="list-style-type: none"> <li>• DND Exceptions</li> <li>• Disable Ringer</li> <li>• Log Out</li> </ul>	<ul style="list-style-type: none"> <li>• Group State</li> <li>• Group Fallback</li> <li>• Self-Administration</li> <li>• System Administration</li> </ul>
--	---	---

### Programmable Button Support

The J139 supports the same programmable button features as other J100 Series telephones except for the following:

<ul style="list-style-type: none"> <li>• Automatic Intercom</li> <li>• Bridged Appearance</li> <li>• Call Intrude</li> <li>• Call Listen</li> <li>• Call Steal</li> </ul>	<ul style="list-style-type: none"> <li>• Coaching Intrusion</li> <li>• Conference Meet Me</li> <li>• Coverage Appearance</li> <li>• Internal Auto-Answer</li> <li>• MADN Call Appearance</li> </ul>	<ul style="list-style-type: none"> <li>• Self-Administer</li> <li>• Set Hunt Group Night Service</li> <li>• Set Hunt Group Out of Service</li> <li>• Set Night Service Destination</li> <li>• Set Out of Service Destination</li> </ul>
---	---	---

- For **Dial** functions, J139 phones only support **Dial**, **Dial Extension** and **Dial Emergency**.

### Related links

[Menus](#) on page 193

# Chapter 33: Entering Text Characters

The method of text entry varies on the type of function.

## Related links

[Entering Characters for a Directory Search](#) on page 198

[Entering Additional and Accented Characters](#) on page 198

[Entering Characters for Other Functions](#) on page 199

---

## Entering Characters for a Directory Search

When searching the directory, the matching names are shown as follows:

- Pressing a key matches all the characters represented by that key: For example, see [How the Directory Search Works](#) on page 96
  - Dialing **5** matches all names starting with **J**, **K** and **L**. Note that the matching is applied to each part of the name.
  - Pressing another key adds the characters from that key. For example: now dialing **2** simultaneously matches all names starting with **JA** and with **KA** plus various others.
  - Pressing another key adds the characters from that key. For example: now dialing **7** simultaneously matches all names starting with **JAS** (for example "Jason") and with **KAR** (for example "Karl") plus others.
- To remove all the characters entered so far, press **Clear**.

## Related links

[Entering Text Characters](#) on page 198

---

## Entering Additional and Accented Characters

### Dialing Additional and Accented Characters

The keys on the telephone number pad can be used to enter characters other than those marked on the button.

For example, though marked with just **ABC**, the 2 key also matches the accented forms of those characters, for example **À**, **Á**, **Â**, **Ã**, **Ä**, **Å** and **Ç**. The set of additional unmarked characters matched varies depending on the language settings of your system.

**Related links**

[Entering Text Characters](#) on page 198

---

## Entering Characters for Other Functions

- Select a character by re-pressing the indicated button until the required character is displayed. Then:
  - Pressing another button enters that character and moves to entering the next character from the newly selected button.
  - Pausing for more than a second after pressing a button also enters the current character and moves to entering the next character.
- You can select the text entry mode. The current mode is shown by the soft-key label as below. Pressing the soft-key switches text entry to the next mode:
  - **abc** – Lower-case.
  - **ABC** – Upper-case.
  - **Abc** – Capitalized.
  - **123** – Number only mode.
  - **Hex** – Hexadecimal only mode.
- Use the left and right cursor keys to move the cursor.
- Press **Bksp** to delete the character before the cursor.

**Related links**

[Entering Text Characters](#) on page 198

# Index

## A

Abbreviated Dial Button .....	<a href="#">169</a>
Absence Text Button .....	<a href="#">169</a>
Accented Characters .....	<a href="#">198</a>
Account Code .....	<a href="#">121</a>
Button .....	<a href="#">169</a>
Forced .....	<a href="#">121</a>
Manual .....	<a href="#">122</a>
Add	
Buttons .....	<a href="#">167</a>
Contact .....	<a href="#">101</a>
Contact from the Call Log .....	<a href="#">102</a> , <a href="#">109</a>
Feature Buttons .....	<a href="#">167</a>
Programmable Buttons .....	<a href="#">167</a>
Additional Calls .....	<a href="#">41</a>
Answer .....	<a href="#">49</a>
AGC	
Headset .....	<a href="#">126</a>
Speaker .....	<a href="#">133</a>
Alerting .....	<a href="#">148</a>
Auto-Answer .....	<a href="#">150</a>
Coverage Ring .....	<a href="#">149</a>
Headset .....	<a href="#">129</a>
Off .....	<a href="#">148</a>
Visual Alerting .....	<a href="#">149</a>
Volume .....	<a href="#">150</a>
Analog phone .....	<a href="#">14</a>
Answer .....	<a href="#">48</a>
Answer another call .....	<a href="#">49</a>
Call .....	<a href="#">48</a>
Call Pickup .....	<a href="#">52</a>
Drop .....	<a href="#">50</a>
Page .....	<a href="#">51</a>
Pickup Call .....	<a href="#">52</a>
Send to voicemail .....	<a href="#">50</a>
Appearance Buttons .....	<a href="#">36</a> , <a href="#">37</a>
Bridged Appearance .....	<a href="#">35</a>
Call Appearance .....	<a href="#">35</a>
Call Coverage .....	<a href="#">35</a>
Line Appearance .....	<a href="#">35</a>
Attention Ring .....	<a href="#">149</a>
Auto-Answer .....	<a href="#">150</a>
Button .....	<a href="#">169</a>
Auto Display Waiting Call .....	<a href="#">155</a>
Auto Lock .....	<a href="#">139</a>
Automatic Gain Control .....	<a href="#">165</a>
Headset .....	<a href="#">126</a>
Speaker .....	<a href="#">133</a>
Auto-Return	
Display .....	<a href="#">155</a>

## B

Background Image .....	<a href="#">156</a>
Backlight Timer .....	<a href="#">156</a>
Block Calls .....	<a href="#">82</a>
Bluetooth Headset .....	<a href="#">127</a>
Bridged Appearance .....	<a href="#">35</a> , <a href="#">37</a>
Brightness .....	<a href="#">151</a>
Broadcast .....	<a href="#">44</a>
Answer .....	<a href="#">51</a>
Page Button .....	<a href="#">172</a>
Busy .....	<a href="#">44</a>
Forward Calls .....	<a href="#">76</a>
Button	
Abbreviated Dial .....	<a href="#">169</a>
Absence Text .....	<a href="#">169</a>
Account Code .....	<a href="#">169</a>
Auto-Answer .....	<a href="#">169</a>
Broadcast .....	<a href="#">172</a>
Call Park .....	<a href="#">170</a>
Call Pickup .....	<a href="#">171</a>
Call Pickup Any .....	<a href="#">171</a>
Clicks .....	<a href="#">161</a>
Conference .....	<a href="#">171</a>
DND .....	<a href="#">173</a>
Do Not Disturb .....	<a href="#">173</a>
Drop .....	<a href="#">171</a>
Flash Hook .....	<a href="#">172</a>
Forward .....	<a href="#">170</a>
Group .....	<a href="#">172</a>
Hunt Group .....	<a href="#">172</a>
Mobile Twin .....	<a href="#">173</a>
Page .....	<a href="#">172</a>
Park .....	<a href="#">170</a>
Park and Page .....	<a href="#">172</a>
Pickup .....	<a href="#">171</a>
Pickup Any .....	<a href="#">171</a>
Recall .....	<a href="#">172</a>
Ringer Off .....	<a href="#">172</a>
Self-Administer .....	<a href="#">173</a>
Send All Calls .....	<a href="#">173</a>
Suppress Digits .....	<a href="#">173</a>
Twinning .....	<a href="#">173</a>
User .....	<a href="#">174</a>
Button Module .....	<a href="#">24</a>
Buttons .....	<a href="#">26</a> , <a href="#">167</a>
Feature Buttons .....	<a href="#">29</a>
Programmable Buttons .....	<a href="#">29</a>

## C

Call	
Answer .....	<a href="#">48</a>



Call ( <i>continued</i> )		Conference ( <i>continued</i> )	
Broadcast	<a href="#">44</a>	Conference phones	<a href="#">131</a>
Call details	<a href="#">107</a>	Details	<a href="#">69</a>
Conference	<a href="#">67</a>	Drop party	<a href="#">70</a>
Display Waiting Call	<a href="#">155</a>	Drop yourself	<a href="#">70</a>
Drop	<a href="#">50</a>	Exit	<a href="#">70</a>
Duration Display	<a href="#">153</a>	Hold	<a href="#">59, 70</a>
End	<a href="#">47</a>	Mute party	<a href="#">70</a>
Forward	<a href="#">76</a>	Short Codes	<a href="#">72</a>
From the Directory	<a href="#">100</a>	Contacts	<a href="#">95, 198</a>
Hold	<a href="#">59, 60</a>	Add	<a href="#">101</a>
Ignore	<a href="#">50</a>	Add from the Call Log	<a href="#">102</a>
Mute	<a href="#">47</a>	Call from	<a href="#">41</a>
Page	<a href="#">44</a>	Delete	<a href="#">103</a>
Park	<a href="#">63</a>	Edit	<a href="#">103</a>
Recall	<a href="#">43, 55</a>	Make a call	<a href="#">100</a>
Redial	<a href="#">43, 54, 55</a>	Search	<a href="#">96</a>
Send to voicemail	<a href="#">50</a>	Context Sensitive	
Timer Display	<a href="#">153</a>	Conferencing	<a href="#">71</a>
Unhold	<a href="#">60</a>	Contrast	<a href="#">152</a>
View Details	<a href="#">107</a>	Coverage Ring	<a href="#">149</a>
Call Appearance	<a href="#">35, 36</a>	Cursor Keys	<a href="#">26</a>
Callback Call	<a href="#">40</a>		
Call Coverage	<a href="#">35, 37</a>	<b>D</b>	
Call Log	<a href="#">105</a>	Default Audio Path	<a href="#">127, 132, 165</a>
Add to contacts	<a href="#">109</a>	Delete	
Delete All	<a href="#">109</a>	Call Log	<a href="#">109</a>
Delete call	<a href="#">108</a>	Contact	<a href="#">103</a>
Make a call from	<a href="#">107</a>	From the Call Log	<a href="#">108</a>
Making calls	<a href="#">42</a>	Details	
Redial	<a href="#">54</a>	Call Details	<a href="#">107</a>
Call Park Button	<a href="#">170</a>	Dialing	
Call Pickup	<a href="#">52</a>	Text	<a href="#">198</a>
Call Pickup Any Button	<a href="#">171</a>	Dialing Codes	<a href="#">176</a>
Call Pickup Button	<a href="#">171</a>	Call Pickup	<a href="#">53</a>
Calls	<a href="#">40</a>	Conference	<a href="#">72</a>
Additional Calls	<a href="#">41</a>	Do Not Disturb	<a href="#">84</a>
Busy	<a href="#">44</a>	Follow Me	<a href="#">87</a>
Call Log	<a href="#">105</a>	Forwarding	<a href="#">80</a>
History	<a href="#">105</a>	Group	<a href="#">146</a>
Making Calls	<a href="#">40</a>	Login	<a href="#">140</a>
Missed Calls	<a href="#">105</a>	Park	<a href="#">63</a>
Cellular	<a href="#">89</a>	Voicemail	<a href="#">118</a>
Change		Directory	<a href="#">95</a>
Buttons	<a href="#">167</a>	Add	<a href="#">101</a>
Contacts	<a href="#">103</a>	Add from the Call Log	<a href="#">102</a>
Feature Buttons	<a href="#">167</a>	Call from	<a href="#">41</a>
Programmable Buttons	<a href="#">167</a>	Edit	<a href="#">103</a>
Clock		Make a call	<a href="#">100</a>
Screen Saver	<a href="#">159</a>	Search	<a href="#">96, 198</a>
Code		Display	<a href="#">32, 151</a>
Login	<a href="#">137</a>	Auto-Return	<a href="#">155</a>
Mailbox	<a href="#">117</a>	Background Image	<a href="#">156</a>
Security PIN	<a href="#">137</a>	Backlight Timer	<a href="#">156</a>
Columns	<a href="#">152</a>	Brightness	<a href="#">151</a>
Conference	<a href="#">67</a>	Call Duration	<a href="#">153</a>
Button	<a href="#">171</a>		

## Index

### Display (continued)

Call Timer .....	<a href="#">153</a>
Columns .....	<a href="#">152</a>
Contrast .....	<a href="#">152</a>
Idle Timer .....	<a href="#">155</a>
Language .....	<a href="#">154</a>
Screen Saver .....	<a href="#">158</a>
Soft Keys .....	<a href="#">28</a>
Text Size .....	<a href="#">157</a>
Waiting Call .....	<a href="#">155</a>
Display Keys .....	<a href="#">28</a>
Divert .....	<a href="#">74, 76</a>
DND .....	<a href="#">82</a>
Button .....	<a href="#">173</a>
Exceptions .....	<a href="#">83</a>
Do Not Disturb .....	<a href="#">74, 82</a>
Button .....	<a href="#">173</a>
Exceptions .....	<a href="#">83</a>
Short Codes .....	<a href="#">84</a>
Double beeps .....	<a href="#">59</a>
Drop .....	<a href="#">50</a>
Button .....	<a href="#">171</a>
Call .....	<a href="#">47</a>
Party from conference .....	<a href="#">70</a>
Yourself from a Conference .....	<a href="#">70</a>
Dual-Column .....	<a href="#">152</a>
Duration .....	<a href="#">153</a>

## E

EC500 .....	<a href="#">89</a>
Edit .....	
Buttons .....	<a href="#">167</a>
Contact .....	<a href="#">103</a>
Feature Buttons .....	<a href="#">167</a>
Programmable Buttons .....	<a href="#">167</a>
Email .....	
Voicemail Email .....	<a href="#">115</a>
En-Bloc Dialing .....	<a href="#">45</a>
End Call .....	<a href="#">47</a>
Erase .....	
Call Log .....	<a href="#">109</a>
Error Tones .....	<a href="#">162</a>
Exceptions .....	<a href="#">83</a>
Extension .....	
Use Two .....	<a href="#">89</a>
Extension to Cellular .....	<a href="#">89</a>

## F

Fallback .....	
Group .....	<a href="#">143</a>
Twinning .....	<a href="#">74, 89</a>
Feature Buttons .....	<a href="#">29, 167</a>
Features Menu .....	<a href="#">194</a>
Flash Hook Button .....	<a href="#">172</a>
Follow Me .....	<a href="#">74, 85</a>

### Follow Me (continued)

Short Codes .....	<a href="#">87</a>
Forward .....	<a href="#">74, 76</a>
Button .....	<a href="#">170</a>
Short Codes .....	<a href="#">80</a>

## G

Greeting .....	<a href="#">115</a>
Group .....	<a href="#">141</a>
Button .....	<a href="#">172</a>
Fallback .....	<a href="#">143</a>
Membership .....	<a href="#">141</a>
Missed Calls .....	<a href="#">106</a>
Night Service .....	<a href="#">143</a>
Page .....	<a href="#">44</a>
Short Codes .....	<a href="#">146</a>
Status .....	<a href="#">143</a>

## H

Handset .....	
Automatic Gain Control .....	<a href="#">165</a>
Profile .....	<a href="#">163</a>
Handsfree .....	<a href="#">131</a>
Audio Path .....	<a href="#">165</a>
Default .....	<a href="#">127</a>
Default to speaker .....	<a href="#">132</a>
Volume .....	<a href="#">132</a>
Headset .....	<a href="#">123</a>
Alert .....	<a href="#">129</a>
Automatic Gain Control .....	<a href="#">126, 165</a>
Bluetooth .....	<a href="#">127</a>
Default Handsfree Audio Path .....	<a href="#">165</a>
Default to .....	<a href="#">127</a>
Profile .....	<a href="#">125, 164</a>
Select .....	<a href="#">129</a>
Volume .....	<a href="#">124</a>
History .....	<a href="#">105</a>
Redial .....	<a href="#">54</a>
Hold .....	<a href="#">59, 60</a>
Conference .....	<a href="#">59, 70</a>
Pending Transfer .....	<a href="#">71</a>
Transfer .....	<a href="#">57, 61</a>
versus Park .....	<a href="#">63</a>
Hunt Group .....	<a href="#">141</a>
Button .....	<a href="#">172</a>
Fallback .....	<a href="#">143</a>
Membership .....	<a href="#">141</a>
Night Service .....	<a href="#">143</a>
Short Codes .....	<a href="#">146</a>
Status .....	<a href="#">143</a>

## I

Icons .....	<a href="#">30</a>
-------------	--------------------

Idle Display Timer ..... [155](#)  
 Idle Line Preference ..... [35](#)  
 Ignore ..... [50](#)  
 Image  
     Background ..... [156](#)  
     Screen Saver ..... [158](#)  
 Internal Auto-Answer ..... [150](#)  
 Internal Twinning ..... [74, 89](#)

**J**

J129 ..... [15](#)  
 J139 ..... [16](#)  
     Restrictions ..... [197](#)  
 J159 ..... [17](#)  
 J169 ..... [19](#)  
     Button Module ..... [24](#)  
 J179 ..... [21](#)  
     Button Module ..... [24](#)  
 J189 ..... [22](#)  
     Button Module ..... [24](#)  
 JBM24 ..... [24](#)  
 JEM24 ..... [24](#)

**K**

Key Clicks ..... [161](#)  
 Keys ..... [26](#)  
     Soft Keys ..... [28](#)

**L**

Language ..... [154](#)  
 Last Number Redial ..... [54](#)  
 Line Appearance ..... [35, 37](#)  
 Line Preference ..... [35](#)  
 Lock ..... [134, 138](#)  
     Auto Lock ..... [139](#)  
 Log ..... [105](#)  
 Logging In ..... [134](#)  
     Login Code ..... [137](#)  
 Logging Out ..... [134](#)  
 Login  
     Short Codes ..... [140](#)

**M**

Mailbox ..... [112](#)  
     Code ..... [117](#)  
     Greeting ..... [115](#)  
     Name ..... [116](#)  
     Short Codes ..... [118](#)  
     Transfer to ..... [118](#)  
 Mailbox guides ..... [119](#)  
 Main Menu ..... [195](#)  
 Making Calls ..... [40](#)

Making Calls (*continued*)

    Additional Calls ..... [41](#)  
     Broadcast ..... [44](#)  
     En-Bloc Dialing ..... [45](#)  
     From Contacts ..... [41](#)  
     From the call log ..... [42](#)  
     From the Call Log ..... [107](#)  
     From the Directory ..... [100](#)  
     On-Hook Dialing ..... [45](#)  
     Page Call ..... [44](#)  
     Recall ..... [43, 55](#)  
     Redial ..... [43, 54, 55](#)  
     Volume ..... [46](#)

Menu ..... [193](#)  
     Access ..... [195](#)  
     Features ..... [194](#)  
     Main Menu ..... [195](#)  
     Status ..... [186, 193](#)

Messages ..... [112](#)  
     Visual Voice ..... [113](#)

Microphone  
     Volume ..... [125](#)

Missed Calls ..... [105](#)  
     Group calls ..... [106](#)

Mobile  
     Mobile Twin Button ..... [173](#)  
     Mobile Twinning ..... [74](#)  
     Number ..... [90](#)  
     Reclaim call ..... [91](#)  
     Transfer to ..... [58, 91](#)  
     Twinning ..... [89](#)

Modify  
     Buttons ..... [167](#)  
     Contacts ..... [103](#)  
     Feature Buttons ..... [167](#)  
     Programmable Buttons ..... [167](#)

Music on Hold ..... [59](#)  
 Mute ..... [47](#)  
     Conference party ..... [70](#)

**N**

Name  
     Voicemail ..... [116](#)

New  
     Contact ..... [101](#)  
     Contact from the Call Log ..... [102, 109](#)  
     Night Service Group ..... [143](#)

No Answer  
     Forward Calls ..... [76](#)

No Calls ..... [74, 82](#)  
     Exceptions ..... [83](#)

Number Withhold ..... [46](#)

**O**

OK Button ..... [26](#)

## Index

one-X Portal .....	<a href="#">14</a>	Redirect Calls .....	<a href="#">74, 76</a>
On-Hook Dialing .....	<a href="#">45</a>	Remove	
<b>P</b>		Call Log .....	<a href="#">109</a>
Page		Contact .....	<a href="#">103</a>
Answer .....	<a href="#">51</a>	From the Call Log .....	<a href="#">108</a>
Button .....	<a href="#">172</a>	Replace	
make a Page Call .....	<a href="#">44</a>	Buttons .....	<a href="#">167</a>
Park and Page .....	<a href="#">65</a>	Feature Buttons .....	<a href="#">167</a>
Park .....	<a href="#">63</a>	Programmable Buttons .....	<a href="#">167</a>
Button .....	<a href="#">170</a>	Restrictions	
Park and Page .....	<a href="#">65</a>	J139 .....	<a href="#">197</a>
Short Code .....	<a href="#">63</a>	Menu Access .....	<a href="#">195</a>
Park and Page Button .....	<a href="#">172</a>	Retrieve	
Password		Held Call .....	<a href="#">60</a>
Login .....	<a href="#">137</a>	Twinned Call .....	<a href="#">91</a>
Mailbox .....	<a href="#">117</a>	Ringer .....	<a href="#">148</a>
Personal Contacts .....	<a href="#">95</a>	Auto-Answer .....	<a href="#">150</a>
Phone		Coverage Ring .....	<a href="#">149</a>
Auto Lock .....	<a href="#">139</a>	Headset .....	<a href="#">129</a>
J129 .....	<a href="#">15</a>	Off .....	<a href="#">148</a>
J139 .....	<a href="#">16</a>	Ringer Off Button .....	<a href="#">172</a>
J159 .....	<a href="#">17</a>	Silence .....	<a href="#">50</a>
J169 .....	<a href="#">19</a>	Visual Alerting .....	<a href="#">149</a>
J179 .....	<a href="#">21</a>	Volume .....	<a href="#">150</a>
J189 .....	<a href="#">22</a>	Ringing Line Preference .....	<a href="#">35</a>
Language .....	<a href="#">154</a>	<b>S</b>	
Lock .....	<a href="#">138</a>	Screen .....	<a href="#">151</a>
Unlock .....	<a href="#">138</a>	Auto-Return .....	<a href="#">155</a>
Phone Book .....	<a href="#">95</a>	Background Image .....	<a href="#">156</a>
Phone Stand .....	<a href="#">25</a>	Backlight Timer .....	<a href="#">156</a>
Pickup .....	<a href="#">52</a>	Brightness .....	<a href="#">151</a>
Pickup Any Button .....	<a href="#">171</a>	Call Duration .....	<a href="#">153</a>
Pickup Button .....	<a href="#">171</a>	Call Timer .....	<a href="#">153</a>
PIN Code		Columns .....	<a href="#">152</a>
Login .....	<a href="#">137</a>	Contrast .....	<a href="#">152</a>
Mailbox .....	<a href="#">117</a>	Idle Timer .....	<a href="#">155</a>
Profile		Language .....	<a href="#">154</a>
Handset .....	<a href="#">163</a>	Screen Saver .....	<a href="#">158</a>
Headset .....	<a href="#">125, 164</a>	Text Size .....	<a href="#">157</a>
Programmable Buttons .....	<a href="#">29, 167</a>	Screen Saver .....	<a href="#">158</a>
Button Modules .....	<a href="#">24</a>	Clock .....	<a href="#">159</a>
Prompts .....	<a href="#">119</a>	Image .....	<a href="#">158</a>
<b>Q</b>		Search .....	<a href="#">198</a>
Quick reference guides .....	<a href="#">14</a>	Directory .....	<a href="#">96</a>
<b>R</b>		Security PIN .....	<a href="#">137</a>
Recall .....	<a href="#">42, 43, 55</a>	Mailbox .....	<a href="#">117</a>
Button .....	<a href="#">172</a>	Self-Administer Button .....	<a href="#">173</a>
Reclaim Twinned Call .....	<a href="#">91</a>	Self-Administration .....	<a href="#">14</a>
Redial .....	<a href="#">42, 43, 54, 55</a>	Send All Calls .....	<a href="#">74, 76</a>
Redial Mode .....	<a href="#">55</a>	Button .....	<a href="#">173</a>
		Share an extension .....	<a href="#">85</a>
		Short Codes .....	<a href="#">176</a>
		Call Pickup .....	<a href="#">53</a>
		Conference .....	<a href="#">72</a>
		Do Not Disturb .....	<a href="#">84</a>

<b>Short Codes (continued)</b>		<b>Tones (continued)</b>	
Follow Me .....	<a href="#">87</a>	Error Tones .....	<a href="#">162</a>
Forwarding .....	<a href="#">80</a>	Transfer .....	<a href="#">56</a>
Group .....	<a href="#">146</a>	Held Call .....	<a href="#">57, 61</a>
Login .....	<a href="#">140</a>	Mobile .....	<a href="#">58</a>
Park .....	<a href="#">63</a>	To Mobile Twin .....	<a href="#">91</a>
Voicemail .....	<a href="#">118</a>	To Voicemail .....	<a href="#">57, 118</a>
Show Last Call Duration .....	<a href="#">153</a>	<b>Twin</b>	
Single-Column .....	<a href="#">152</a>	Reclaim call .....	<a href="#">91</a>
Soft Keys .....	<a href="#">26, 28</a>	Transfer to .....	<a href="#">58, 91</a>
Sound .....	<a href="#">161</a>	Twinning .....	<a href="#">74, 89</a>
Speaker .....	<a href="#">131</a>	Button .....	<a href="#">173</a>
Automatic Gain Control .....	<a href="#">133, 165</a>	Number .....	<a href="#">90</a>
Default Handsfree Audio Path .....	<a href="#">165</a>		
Default to .....	<a href="#">132</a>	<b>U</b>	
Volume .....	<a href="#">132</a>	Unanswered Calls .....	<a href="#">105</a>
Spoken prompts .....	<a href="#">119</a>	Unhold .....	<a href="#">60</a>
Stand .....	<a href="#">25</a>	Unlock .....	<a href="#">134, 138</a>
Status .....	<a href="#">32</a>	Unmute .....	<a href="#">47</a>
Busy .....	<a href="#">44</a>	Unpark .....	<a href="#">63</a>
Icons .....	<a href="#">32</a>	User Button .....	<a href="#">174</a>
Letters .....	<a href="#">33</a>	User guides .....	<a href="#">14</a>
Menu .....	<a href="#">193</a>		
Status Menu .....	<a href="#">186</a>	<b>V</b>	
Suppress Digits Button .....	<a href="#">173</a>	View conference details .....	<a href="#">69</a>
System Administration .....	<a href="#">179</a>	Visual Voice .....	<a href="#">113</a>
System Directory .....	<a href="#">95</a>	Voicemail .....	<a href="#">112</a>
		Code .....	<a href="#">117</a>
<b>T</b>		Forward to .....	<a href="#">76</a>
Telephone		Greeting .....	<a href="#">115</a>
Auto Lock .....	<a href="#">139</a>	Name .....	<a href="#">116</a>
J129 .....	<a href="#">15</a>	Send call to voicemail .....	<a href="#">50</a>
J139 .....	<a href="#">16</a>	Short Codes .....	<a href="#">118</a>
J159 .....	<a href="#">17</a>	Transfer .....	<a href="#">57</a>
J169 .....	<a href="#">19</a>	Transfer to .....	<a href="#">118</a>
J179 .....	<a href="#">21</a>	Visual Voice .....	<a href="#">113</a>
J189 .....	<a href="#">22</a>	Voicemail Email .....	<a href="#">115</a>
Lock .....	<a href="#">138</a>	Voicemail guides .....	<a href="#">119</a>
Unlock .....	<a href="#">138</a>	Volume .....	<a href="#">161</a>
Telephone Numbers .....	<a href="#">95</a>	Call .....	<a href="#">46</a>
Temporary redirect .....	<a href="#">85</a>	Handset .....	<a href="#">162</a>
Text		Handsfree .....	<a href="#">132</a>
Accented Characters .....	<a href="#">198</a>	Headset .....	<a href="#">124, 163</a>
Entering text .....	<a href="#">198</a>	Microphone .....	<a href="#">125</a>
Size .....	<a href="#">157</a>	Ringer .....	<a href="#">150, 162</a>
<b>Time</b>		Speaker .....	<a href="#">132, 165</a>
Call Timer .....	<a href="#">153</a>		
Last Call Duration .....	<a href="#">153</a>	<b>W</b>	
Screen Saver .....	<a href="#">159</a>	Web Collaboration .....	<a href="#">14</a>
<b>Timer</b>		Withhold Number .....	<a href="#">46</a>
Backlight Timer .....	<a href="#">156</a>		
Screen Saver .....			
Timer .....	<a href="#">159</a>		
<b>Tones</b>			
Button Clicks .....	<a href="#">161</a>		
Double beeps .....	<a href="#">59</a>		