



# Using Avaya Vantage™ and Avaya Vantage™ Basic

Release 2.0  
Issue 2  
September 2018

© 2017-2018, Avaya Inc.  
All Rights Reserved.

#### Note

Using a cell, mobile, or GSM phone, or a two-way radio in close proximity to an Avaya IP telephone might cause interference.

#### Documentation disclaimer

"Documentation" means information published in varying mediums which may include product information, operating instructions and performance specifications that are generally made available to users of products. Documentation does not include marketing materials. Avaya shall not be responsible for any modifications, additions, or deletions to the original published version of Documentation unless such modifications, additions, or deletions were performed by or on the express behalf of Avaya. End User agrees to indemnify and hold harmless Avaya, Avaya's agents, servants and employees against all claims, lawsuits, demands and judgments arising out of, or in connection with, subsequent modifications, additions or deletions to this documentation, to the extent made by End User.

#### Link disclaimer

Avaya is not responsible for the contents or reliability of any linked websites referenced within this site or Documentation provided by Avaya. Avaya is not responsible for the accuracy of any information, statement or content provided on these sites and does not necessarily endorse the products, services, or information described or offered within them. Avaya does not guarantee that these links will work all the time and has no control over the availability of the linked pages.

#### Warranty

Avaya provides a limited warranty on Avaya hardware and software. Refer to your sales agreement to establish the terms of the limited warranty. In addition, Avaya's standard warranty language, as well as information regarding support for this product while under warranty is available to Avaya customers and other parties through the Avaya Support website: <https://support.avaya.com/helpcenter/getGenericDetails?detailId=C20091120112456651010> under the link "Warranty & Product Lifecycle" or such successor site as designated by Avaya. Please note that if You acquired the product(s) from an authorized Avaya Channel Partner outside of the United States and Canada, the warranty is provided to You by said Avaya Channel Partner and not by Avaya.

"Hosted Service" means an Avaya hosted service subscription that You acquire from either Avaya or an authorized Avaya Channel Partner (as applicable) and which is described further in Hosted SAS or other service description documentation regarding the applicable hosted service. If You purchase a Hosted Service subscription, the foregoing limited warranty may not apply but You may be entitled to support services in connection with the Hosted Service as described further in your service description documents for the applicable Hosted Service. Contact Avaya or Avaya Channel Partner (as applicable) for more information.

#### Hosted Service

THE FOLLOWING APPLIES ONLY IF YOU PURCHASE AN AVAYA HOSTED SERVICE SUBSCRIPTION FROM AVAYA OR AN AVAYA CHANNEL PARTNER (AS APPLICABLE), THE TERMS OF USE FOR HOSTED SERVICES ARE AVAILABLE ON THE AVAYA WEBSITE, [HTTPS://SUPPORT.AVAYA.COM/LICENSEINFO](https://support.avaya.com/LICENSEINFO) UNDER THE LINK "Avaya Terms of Use for Hosted Services" OR SUCH SUCCESSOR SITE AS DESIGNATED BY AVAYA, AND ARE APPLICABLE TO ANYONE WHO ACCESSES OR USES THE HOSTED SERVICE. BY ACCESSING OR USING THE HOSTED SERVICE, OR AUTHORIZING OTHERS TO DO SO, YOU, ON BEHALF OF YOURSELF AND THE ENTITY FOR WHOM YOU ARE DOING SO (HEREINAFTER REFERRED TO INTERCHANGEABLY AS "YOU" AND "END USER"), AGREE TO THE TERMS OF USE. IF YOU ARE ACCEPTING THE TERMS OF USE ON BEHALF A COMPANY OR OTHER LEGAL ENTITY, YOU REPRESENT THAT YOU HAVE THE AUTHORITY TO BIND SUCH ENTITY TO THESE TERMS OF USE. IF YOU DO NOT HAVE SUCH AUTHORITY, OR IF YOU DO NOT WISH TO ACCEPT THESE TERMS OF USE, YOU MUST NOT ACCESS OR USE THE HOSTED SERVICE OR AUTHORIZE ANYONE TO ACCESS OR USE THE HOSTED SERVICE.

#### Licenses

THE SOFTWARE LICENSE TERMS AVAILABLE ON THE AVAYA WEBSITE, [HTTPS://SUPPORT.AVAYA.COM/LICENSEINFO](https://support.avaya.com/LICENSEINFO), UNDER THE LINK "AVAYA SOFTWARE LICENSE TERMS (Avaya Products)" OR SUCH SUCCESSOR SITE AS DESIGNATED BY AVAYA, ARE APPLICABLE TO ANYONE WHO DOWNLOADS, USES AND/OR INSTALLS AVAYA SOFTWARE, PURCHASED FROM AVAYA INC., ANY AVAYA AFFILIATE, OR AN AVAYA CHANNEL PARTNER (AS APPLICABLE) UNDER A COMMERCIAL AGREEMENT WITH AVAYA OR AN AVAYA CHANNEL PARTNER. UNLESS OTHERWISE AGREED TO BY AVAYA IN WRITING, AVAYA DOES NOT EXTEND THIS LICENSE IF THE SOFTWARE WAS OBTAINED FROM ANYONE OTHER THAN AVAYA, AN AVAYA AFFILIATE OR AN AVAYA CHANNEL PARTNER; AVAYA RESERVES THE RIGHT TO TAKE LEGAL ACTION AGAINST YOU AND ANYONE ELSE USING OR SELLING THE SOFTWARE WITHOUT A LICENSE. BY INSTALLING, DOWNLOADING OR USING THE SOFTWARE, OR AUTHORIZING OTHERS TO DO SO, YOU, ON BEHALF OF YOURSELF AND THE ENTITY FOR WHOM YOU ARE INSTALLING, DOWNLOADING OR USING THE SOFTWARE (HEREINAFTER REFERRED TO INTERCHANGEABLY AS "YOU" AND "END USER"), AGREE TO THESE TERMS AND CONDITIONS AND CREATE A BINDING CONTRACT BETWEEN YOU AND AVAYA INC. OR THE APPLICABLE AVAYA AFFILIATE ("AVAYA").

Avaya grants You a license within the scope of the license types described below, with the exception of Heritage Nortel Software, for which the scope of the license is detailed below. Where the order documentation does not expressly identify a license type, the applicable license will be a Designated System License as set forth below in the Designated System(s) License (DS) section as applicable. The applicable number of licenses and units of capacity for which the license is granted will be one (1), unless a different number of licenses or units of capacity is specified in the documentation or other materials available to You. "Software" means computer programs in object code, provided by Avaya or an Avaya Channel Partner, whether as stand-alone products, pre-installed on hardware products, and any upgrades, updates, patches, bug fixes, or modified versions thereto. "Designated Processor" means a single stand-alone computing device. "Server" means a set of Designated Processors that hosts (physically or virtually) a software application to be accessed by multiple users. "Instance" means a single copy of the Software executing at a particular time: (i) on one physical machine; or (ii) on one deployed software virtual machine ("VM") or similar deployment.

#### License types

Designated System(s) License (DS). End User may install and use each copy or an Instance of the Software only: 1) on a number of Designated Processors up to the number indicated in the order; or 2) up to the number of Instances of the Software as indicated in the order, Documentation, or as authorized by Avaya in writing. Avaya may require the Designated Processor(s) to be identified in the order by type, serial number, feature key, Instance, location or other specific designation, or to be provided by End User to Avaya through electronic means established by Avaya specifically for this purpose.

Shrinkwrap License (SR). You may install and use the Software in accordance with the terms and conditions of the applicable license agreements, such as "shrinkwrap" or "clickthrough" license accompanying or applicable to the Software ("Shrinkwrap License").

#### Heritage Nortel Software

"Heritage Nortel Software" means the software that was acquired by Avaya as part of its purchase of the Nortel Enterprise Solutions Business in December 2009. The Heritage Nortel Software is the software contained within the list of Heritage Nortel Products located at <https://support.avaya.com/LicenseInfo> under the link "Heritage Nortel Products" or such successor site as designated by Avaya. For Heritage Nortel Software, Avaya grants Customer a license to use Heritage Nortel Software provided hereunder solely to the extent of the authorized activation or authorized usage level, solely for the purpose specified in the Documentation, and solely as embedded in, for execution on, or for communication with Avaya equipment. Charges for Heritage Nortel Software may be based on extent of activation or use authorized as specified in an order or invoice.

## Copyright

Except where expressly stated otherwise, no use should be made of materials on this site, the Documentation, Software, Hosted Service, or hardware provided by Avaya. All content on this site, the documentation, Hosted Service, and the product provided by Avaya including the selection, arrangement and design of the content is owned either by Avaya or its licensors and is protected by copyright and other intellectual property laws including the sui generis rights relating to the protection of databases. You may not modify, copy, reproduce, republish, upload, post, transmit or distribute in any way any content, in whole or in part, including any code and software unless expressly authorized by Avaya. Unauthorized reproduction, transmission, dissemination, storage, and or use without the express written consent of Avaya can be a criminal, as well as a civil offense under the applicable law.

## Virtualization

The following applies if the product is deployed on a virtual machine. Each product has its own ordering code and license types. Note, unless otherwise stated, that each Instance of a product must be separately licensed and ordered. For example, if the end user customer or Avaya Channel Partner would like to install two Instances of the same type of products, then two products of that type must be ordered.

## Third Party Components

"Third Party Components" mean certain software programs or portions thereof included in the Software or Hosted Service may contain software (including open source software) distributed under third party agreements ("Third Party Components"), which contain terms regarding the rights to use certain portions of the Software ("Third Party Terms"). As required, information regarding distributed Linux OS source code (for those products that have distributed Linux OS source code) and identifying the copyright holders of the Third Party Components and the Third Party Terms that apply is available in the products, Documentation or on Avaya's website at: <https://support.avaya.com/Copyright> or such successor site as designated by Avaya. The open source software license terms provided as Third Party Terms are consistent with the license rights granted in these Software License Terms, and may contain additional rights benefiting You, such as modification and distribution of the open source software. The Third Party Terms shall take precedence over these Software License Terms, solely with respect to the applicable Third Party Components to the extent that these Software License Terms impose greater restrictions on You than the applicable Third Party Terms.

The following applies only if the H.264 (AVC) codec is distributed with the product. THIS PRODUCT IS LICENSED UNDER THE AVC PATENT PORTFOLIO LICENSE FOR THE PERSONAL USE OF A CONSUMER OR OTHER USES IN WHICH IT DOES NOT RECEIVE REMUNERATION TO (i) ENCODE VIDEO IN COMPLIANCE WITH THE AVC STANDARD ("AVC VIDEO") AND/OR (ii) DECODE AVC VIDEO THAT WAS ENCODED BY A CONSUMER ENGAGED IN A PERSONAL ACTIVITY AND/OR WAS OBTAINED FROM A VIDEO PROVIDER LICENSED TO PROVIDE AVC VIDEO. NO LICENSE IS GRANTED OR SHALL BE IMPLIED FOR ANY OTHER USE. ADDITIONAL INFORMATION MAY BE OBTAINED FROM MPEG LA, L.L.C. SEE [HTTP://WWW.MPEGLA.COM](http://www.mpegla.com).

## Service Provider

THE FOLLOWING APPLIES TO AVAYA CHANNEL PARTNER'S HOSTING OF AVAYA PRODUCTS OR SERVICES. THE PRODUCT OR HOSTED SERVICE MAY USE THIRD PARTY COMPONENTS SUBJECT TO THIRD PARTY TERMS AND REQUIRE A SERVICE PROVIDER TO BE INDEPENDENTLY LICENSED DIRECTLY FROM THE THIRD PARTY SUPPLIER. AN AVAYA CHANNEL PARTNER'S HOSTING OF AVAYA PRODUCTS MUST BE AUTHORIZED IN WRITING BY AVAYA AND IF THOSE HOSTED PRODUCTS USE OR EMBED CERTAIN THIRD PARTY SOFTWARE, INCLUDING BUT NOT LIMITED TO MICROSOFT SOFTWARE OR CODECS, THE AVAYA CHANNEL PARTNER IS REQUIRED TO INDEPENDENTLY OBTAIN ANY APPLICABLE LICENSE AGREEMENTS, AT THE AVAYA CHANNEL PARTNER'S EXPENSE, DIRECTLY FROM THE APPLICABLE THIRD PARTY SUPPLIER.

WITH RESPECT TO CODECS, IF THE AVAYA CHANNEL PARTNER IS HOSTING ANY PRODUCTS THAT USE OR EMBED THE G.729 CODEC, H.264 CODEC, OR H.265 CODEC, THE

AVAYA CHANNEL PARTNER ACKNOWLEDGES AND AGREES THE AVAYA CHANNEL PARTNER IS RESPONSIBLE FOR ANY AND ALL RELATED FEES AND/OR ROYALTIES. THE G.729 CODEC IS LICENSED BY SIPRO LAB TELECOM INC. SEE [WWW.SIPRO.COM/CONTACT.HTML](http://WWW.SIPRO.COM/CONTACT.HTML). THE H.264 (AVC) CODEC IS LICENSED UNDER THE AVC PATENT PORTFOLIO LICENSE FOR THE PERSONAL USE OF A CONSUMER OR OTHER USES IN WHICH IT DOES NOT RECEIVE REMUNERATION TO: (I) ENCODE VIDEO IN COMPLIANCE WITH THE AVC STANDARD ("AVC VIDEO") AND/OR (II) DECODE AVC VIDEO THAT WAS ENCODED BY A CONSUMER ENGAGED IN A PERSONAL ACTIVITY AND/OR WAS OBTAINED FROM A VIDEO PROVIDER LICENSED TO PROVIDE AVC VIDEO. NO LICENSE IS GRANTED OR SHALL BE IMPLIED FOR ANY OTHER USE. ADDITIONAL INFORMATION FOR H.264 (AVC) AND H.265 (HEVC) CODECS MAY BE OBTAINED FROM MPEG LA, L.L.C. SEE [HTTP://WWW.MPEGLA.COM](http://WWW.MPEGLA.COM).

## Compliance with Laws

You acknowledge and agree that it is Your responsibility for complying with any applicable laws and regulations, including, but not limited to laws and regulations related to call recording, data privacy, intellectual property, trade secret, fraud, and music performance rights, in the country or territory where the Avaya product is used.

## Preventing Toll Fraud

"Toll Fraud" is the unauthorized use of your telecommunications system by an unauthorized party (for example, a person who is not a corporate employee, agent, subcontractor, or is not working on your company's behalf). Be aware that there can be a risk of Toll Fraud associated with your system and that, if Toll Fraud occurs, it can result in substantial additional charges for your telecommunications services.

## Avaya Toll Fraud intervention

If You suspect that You are being victimized by Toll Fraud and You need technical assistance or support, call Technical Service Center Toll Fraud Intervention Hotline at +1-800-643-2353 for the United States and Canada. For additional support telephone numbers, see the Avaya Support website: <https://support.avaya.com> or such successor site as designated by Avaya.

## Security Vulnerabilities

Information about Avaya's security support policies can be found in the Security Policies and Support section of <https://support.avaya.com/security>.

Suspected Avaya product security vulnerabilities are handled per the Avaya Product Security Support Flow (<https://support.avaya.com/css/P8/documents/100161515>).

## Downloading Documentation

For the most current versions of Documentation, see the Avaya Support website: <https://support.avaya.com>, or such successor site as designated by Avaya.

## Contact Avaya Support

See the Avaya Support website: <https://support.avaya.com> for product or Hosted Service notices and articles, or to report a problem with your Avaya product or Hosted Service. For a list of support telephone numbers and contact addresses, go to the Avaya Support website: <https://support.avaya.com> (or such successor site as designated by Avaya), scroll to the bottom of the page, and select Contact Avaya Support.

## Regulatory Statements

### Australia Statements

### Handset Magnets Statement:

#### Danger:

The handset receiver contains magnetic devices that can attract small metallic objects. Care should be taken to avoid personal injury.

### Industry Canada (IC) Statements

#### RSS Standards Statement

This device complies with Industry Canada licence-exempt RSS standard(s). Operation is subject to the following two conditions:

1. This device may not cause interference, and
2. This device must accept any interference, including interference that may cause undesired operation of the device.

Le présent appareil est conforme aux CNR d'Industrie Canada applicables aux appareils radio exempts de licence. L'exploitation est autorisée aux deux conditions suivantes:

1. L'appareil ne doit pas produire de brouillage, et
2. L'utilisateur de l'appareil doit accepter tout brouillage radioélectrique subi, même si le brouillage est susceptible d'en compromettre le fonctionnement.

#### Radio Transmitter Statement

Under Industry Canada regulations, this radio transmitter may only operate using an antenna of a type and maximum (or lesser) gain approved for the transmitter by Industry Canada. To reduce potential radio interference to other users, the antenna type and its gain should be so chosen that the equivalent isotropically radiated power (EIRP) is not more than that necessary for successful communication.

Conformément à la réglementation d'Industrie Canada, le présent émetteur radio peut fonctionner avec une antenne d'un type et d'un gain maximal (ou inférieur) approuvé pour l'émetteur par Industrie Canada. Dans le but de réduire les risques de brouillage radioélectrique à l'intention des autres utilisateurs, il faut choisir le type d'antenne et son gain de sorte que la puissance isotrope rayonnée équivalente ne dépasse pas l'intensité nécessaire à l'établissement d'une communication satisfaisante.

This Class B digital apparatus complies with Canadian ICES-003.

Cet appareil numérique de la classe B est conforme à la norme NMB-003 du Canada.

#### Radiation Exposure Statement

This equipment complies with FCC & IC RSS102 radiation exposure limits set forth for an uncontrolled environment. This equipment should be installed and operated with minimum distance 20cm between the radiator & your body. This transmitter must not be co-located or operating in conjunction with any other antenna or transmitter.

Cet équipement est conforme aux limites d'exposition aux rayonnements ISED établies pour un environnement non contrôlé. Cet équipement doit être installé et utilisé avec un minimum de 20 cm de distance entre la source de rayonnement et votre corps.

#### Japan Statements

##### Class B Statement

This is a Class B product based on the standard of the VCCI Council. If this is used near a radio or television receiver in a domestic environment, it may cause radio interference. Install and use the equipment according to the instruction manual.

この装置は、クラスB情報技術装置です。この装置は、家庭環境で使用することを目的としていますが、この装置がラジオやテレビジョン受信機に近接して使用されると、受信障害を引き起こすことがあります。

取扱説明書に従って正しい取り扱いをして下さい。 VCCI-B

#### Denan Power Cord Statement



##### Danger:

Please be careful of the following while installing the equipment:

- Please only use the connecting cables, power cord, and AC adapters shipped with the equipment or specified by Avaya to be used with the equipment. If you use any other equipment, it may cause failures, malfunctioning, or fire.
- Power cords shipped with this equipment must not be used with any other equipment. In case the above

guidelines are not followed, it may lead to death or severe injury.



本製品を安全にご使用頂くため、以下のことにご注意ください。

- 接続ケーブル、電源コード、ACアダプタなどの部品は、必ず製品に同梱されており添付品または指定品をご使用ください。添付品指定品以外の部品をご使用になると故障や動作不良、火災の原因となることがあります。
- 同梱されており添付の電源コードを他の機器には使用しないでください。上記注意事項を守らないと、死亡や大怪我等人身事故の原因となることがあります。

#### México Statement

The operation of this equipment is subject to the following two conditions:

1. It is possible that this equipment or device may not cause harmful interference, and
2. This equipment or device must accept any interference, including interference that may cause undesired operation.

La operación de este equipo está sujeta a las siguientes dos condiciones:

1. Es posible que este equipo o dispositivo no cause interferencia perjudicial y
2. Este equipo o dispositivo debe aceptar cualquier interferencia, incluyendo la que pueda causar su operación no deseada.

#### Power over Ethernet (PoE) Statement

This equipment must be connected to PoE networks without routing to the outside plant.

#### U.S. Federal Communications Commission (FCC) Statements

##### Compliance Statement

The changes or modifications not expressly approved by the party responsible for compliance could void the user's authority to operate the equipment.

To comply with the FCC RF exposure compliance requirements, this device and its antenna must not be co-located or operating to conjunction with any other antenna or transmitter.

This device complies with part 15 of the FCC Rules. Operation is subject to the following two conditions:

1. This device may not cause harmful interference, and
2. This device must accept any interference received, including interferences that may cause undesired operation.

This equipment has been tested and found to comply with the limits for a Class B digital device, pursuant to Part 15 of the FCC Rules. These limits are designated to provide reasonable protection against harmful interferences in a residential installation. This equipment generates, uses and can radiate radio frequency energy and, if not installed and used in accordance with the instructions, may cause harmful interference to radio communications. However, there is no guarantee that interference will not occur in a particular installation. If this equipment does cause harmful interferences to radio or television reception, which can be determined by turning the equipment off and on, the user is encouraged to try to correct the interference by one or more of the following measures:

- Reorient or relocate the receiving antenna.
- Increase the separation between the equipment and receiver.
- Connect the equipment into an outlet on a circuit different from that to which the receiver is connected.
- Consult the dealer or an experienced radio/TV technician for help.

### *Radiation Exposure Statement*

This equipment complies with FCC radiation exposure limits set forth for an uncontrolled environment . This equipment should be installed and operated with minimum distance of 8 in or 20 cm between the radiator and your body. This transmitter must not be co-located or operating in conjunction with any other antenna or transmitter.

### **EU Countries**

This device when installed complies with the essential requirements and other relevant provisions of the EMC Directive 2014/30/EU, Safety LV Directive 2014/35/EU, and Radio Equipment Directive 2014/53/EU. A copy of the Declaration may be obtained from <http://support.avaya.com> or Avaya Inc., 4655 Great America Parkway, Santa Clara, CA 95054–1233 USA.

WiFi and BT transmitter

- Frequencies for 2412-2472 MHz, transmit power: 19.84 dBm
- Frequencies for 5180-5240 MHz, transmit power: 22.5 dBm

### **General Safety Warning**

- Use only the Avaya approved Limited Power Source power supplies specified for this product.
- Ensure that you:
  - Do not operate the device near water.
  - Do not use the device during a lightning storm.
  - Do not report a gas leak while in the vicinity of the leak.
  - For Accessory Power Supply - Use Only Limited Power Supply Delta Electronics Inc. model:ADP-30HR B , output: 48Vdc, 0.66A.

### **Trademarks**

The trademarks, logos and service marks (“Marks”) displayed in this site, the Documentation, Hosted Service(s), and product(s) provided by Avaya are the registered or unregistered Marks of Avaya, its affiliates, its licensors, its suppliers, or other third parties. Users are not permitted to use such Marks without prior written consent from Avaya or such third party which may own the Mark. Nothing contained in this site, the Documentation, Hosted Service(s) and product(s) should be construed as granting, by implication, estoppel, or otherwise, any license or right in and to the Marks without the express written permission of Avaya or the applicable third party.

Avaya is a registered trademark of Avaya Inc.

All non-Avaya trademarks are the property of their respective owners. Linux<sup>®</sup> is the registered trademark of Linus Torvalds in the U.S. and other countries.

Android, Google and Google Play are trademarks of Google Inc.

# Contents

<b>Chapter 1: Introduction</b> .....	8
Purpose.....	8
Change history.....	8
<b>Chapter 2: Avaya Vantage™ overview</b> .....	10
Supported features.....	11
Wireless handset features.....	12
Third party applications.....	14
New in this release.....	14
<b>Chapter 3: Getting started with Avaya Vantage™</b> .....	15
Installing applications from Google Play Store on K165 and K175.....	15
Installing applications on K155.....	16
Logging in to and out of Avaya Vantage™.....	16
Locking and unlocking Avaya Vantage™.....	17
Avaya Smart Lock.....	18
Enabling Avaya Smart Lock.....	19
Removing or changing the trusted device.....	20
Locking the device manually when Smart Lock is enabled.....	20
Connecting a wireless handset.....	21
Turning the wireless handset on and off.....	22
<b>Chapter 4: Navigation</b> .....	23
Physical device layout.....	23
Layout of Avaya Vantage™ K165 and K175.....	23
Layout of Avaya Vantage™ K155.....	25
Connectors and controls.....	26
Wireless handset layout.....	30
Avaya Vantage Basic screen navigation.....	30
Dial pad screen.....	30
Contacts screen.....	32
Call screen.....	34
<b>Chapter 5: Call management operations</b> .....	37
Making audio or video calls.....	37
Making an emergency call.....	37
Making an audio or video call by using the dial pad.....	38
Making an audio or video call using contacts.....	38
Making an audio or video call from your Favorites list.....	38
Making an audio or video call using call history.....	39
Making a second call.....	39
Redialing a number.....	40
Managing calls.....	40

Answering, declining, or ignoring an incoming call.....	40
Entering digits during a call.....	41
Muting or unmuting a call.....	41
Placing a call on hold and resuming the call.....	42
Toggling between calls.....	42
Transferring a call.....	42
Working with video functionality.....	43
Selecting the audio device.....	43
Ending a call.....	44
Viewing call history.....	44
Deleting all call information.....	45
Working with conference calls.....	45
Starting a conference call.....	45
Merging calls to create a conference call.....	46
<b>Chapter 6: Contact management operations.....</b>	<b>47</b>
Adding a contact.....	47
Editing a contact.....	48
Deleting a contact.....	48
Searching for a contact.....	49
IP Office contact search options.....	49
Saving an IP Office system contact as a personal contact.....	49
Setting contact display options.....	50
Setting a contact as a favorite.....	50
Synchronizing contacts and call history over Bluetooth.....	50
Filtering contacts.....	51
<b>Chapter 7: Customization.....</b>	<b>53</b>
Modifying the ring tone.....	53
Disabling video by using the privacy shutter on a K175 device.....	53
Changing the wallpaper.....	54
Enabling or disabling the Do Not Disturb mode.....	54
<b>Chapter 8: Resources.....</b>	<b>56</b>
Documentation.....	56
Finding documents on the Avaya Support website.....	56
Avaya Documentation Portal navigation.....	57
Viewing Avaya Mentor videos.....	58
Support.....	58
Using the Avaya InSite Knowledge Base.....	59

# Chapter 1: Introduction

---

## Purpose

This document is intended for end users and describes how to use the Avaya Vantage™ device and the Avaya Vantage™ Basic application. This document also describes setup tasks performed by end users.

Separate documentation is available for SDK developer applications. This document does not provide information about SDK applications.

---

## Change history

The following table describes the major changes made in this document:

Issue	Date	Summary of changes
Release 2.0, Issue 1	July 2018	<ul style="list-style-type: none"><li>• Updated <a href="#">Supported features</a> on page 11.</li><li>• Added IP Office login information in <a href="#">Logging in to and out of Avaya Vantage</a> on page 16.</li><li>• Updated the “Navigation” chapter.</li><li>• Minor rephrasing throughout the document.</li><li>• Added <a href="#">Editing a contact</a> on page 48.</li><li>• Added <a href="#">Deleting a contact</a> on page 48.</li><li>• Updated <a href="#">Filtering contacts</a> on page 51.</li><li>• Added information about <a href="#">IP Office contact search options</a> on page 49 and <a href="#">Saving an IP Office system contact as a personal contact</a> on page 49.</li><li>• Added <a href="#">Enabling or disabling the Do Not Disturb mode</a> on page 54.</li></ul>
Release 2.0, Issue 2	August 2018	<ul style="list-style-type: none"><li>• Added information about the K155 device throughout the document.</li></ul>

*Table continues...*



Issue	Date	Summary of changes
		<ul style="list-style-type: none"><li>• Updated <a href="#">New in this release</a> on page 14.</li><li>• Added <a href="#">Installing applications on K155</a> on page 16.</li></ul>

# Chapter 2: Avaya Vantage™ overview

Avaya Vantage™ is an Android™ device that provides telephony and conferencing functionality. Avaya Vantage™ combines the advantages of a customizable unified communications solution and a fully functional Android device. You can use the Avaya Breeze™ Client Software Development Kit (CSDK) and custom applications to integrate communications into business processes by using your Avaya Vantage™ device.

According to your business needs, you can choose from the following Avaya Vantage™ device variants:

- Avaya Vantage™ K175: Standard device with an 8-inch screen and an integrated camera for full access to video calls and conferences. You can cover the camera by using a mechanical camera shutter.
- Avaya Vantage™ K165: Standard device with an 8-inch screen that does not include an integrated camera. You can still receive video from other users.
- Avaya Vantage™ K155: Device with a small 5-inch screen. The device also includes a physical keypad and an integrated camera.

Avaya Vantage™ supports the following communication applications:

- Avaya Vantage™ Basic
- Avaya Equinox®
- Avaya Vantage™ Open

This document is focused on Avaya Vantage™ Basic usage. For more information about using other applications, see the following documents:

- *Using Avaya Equinox® for Android, iOS, Mac, and Windows*: For how to use Avaya Equinox® clients.

Some features and services are not supported when an Avaya Equinox® client is deployed on Avaya Vantage™. These feature discrepancies are described in the Avaya Equinox® clients documentation.

- *Using Avaya Vantage™ Open*: For how to use Avaya Vantage™ Open.

 **Note:**

- IP Office Release 11.0 only supports Avaya Vantage™ Basic. IP Office Release 11.0 does not support other clients with Avaya Vantage™.

- In Release 2.0, the Avaya Vantage™ K155 device only supports Avaya Vantage™ Basic. It does not support Avaya Equinox® or Avaya Vantage™ Open.

## Supported features

Avaya Vantage™ Basic feature	Supported with Avaya Aura®	Supported with IP Office
Make and receive audio calls	Yes	Yes
Caller ID and call information	Yes	Yes
Multiple line support	Yes	Yes <sup>1</sup>
Feature Access Codes (FACs) <sup>2</sup>	Yes	Yes
Mute calls	Yes	Yes
Hold calls	Yes	Yes
Transfer calls	Yes	Yes
Forward calls	Yes, through FACs	Yes, through FACs or short codes
Toggle calls	Yes	Yes
Conferencing	Yes	Yes
Missed calls indication	Yes	Yes
Message Waiting Indication (MWI)	Yes	Yes
Video calls	Yes	Yes
Emergency calls	Yes	Yes <sup>3</sup>
Off Hook dialing	Yes	Yes
Call logs	Yes	Yes <sup>4</sup>
PPM contacts	Yes	No
Local contacts, including Google™ and Microsoft Exchange contacts	Yes	Yes
Favorites	Yes	Yes Only local contacts can be added to the Favorites list

*Table continues...*

<sup>1</sup> For multiple line support to work on IP Office, you must enable the Call Waiting On feature for the user account. Otherwise the connection is treated as a single line.

<sup>2</sup> Avaya Vantage™ Basic does not have any UI representation for the FAC status. For example, if EC500 is enabled in the Avaya Aura® environment, then the UI of Avaya Vantage™ Basic does not indicate that EC500 is enabled.

<sup>3</sup> In the IP Office environment, you can make an emergency call only when you are logged in to Avaya Vantage™. You can make an emergency call from a locked device if the Lock mode is enabled and an administrator has configured emergency numbers in the `46xxspecials.txt` file.

<sup>4</sup> Call logs in IP Office are local to the device.

Avaya Vantage™ Basic feature	Supported with Avaya Aura®	Supported with IP Office
Presence	No	No
Instant Messaging	No	No

**!** **Important:**

IP Office Release 11.0 only supports Avaya Vantage™ Basic. IP Office Release 11.0 does not support other telephony applications on Avaya Vantage™.

---

## Wireless handset features

A wired or wireless handset can optionally be used with Avaya Vantage™. The following section describes the wireless handset features.

### Range

The handset uses Bluetooth technology. As a Class 2 device, the handset nominal range is 10 meters. In practical use this range might vary depending on the environment. If the handset was out of range, the connection is reestablished automatically when the handset is back in range. When the handset is not in range for more than 22 minutes, it turns off to prevent battery discharge. If the handset was turned off, the connection is reestablished automatically when the handset is turned on and back in range.

### Battery service life

If used carefully, the expected service life of the battery is several years. Although the battery capacity is diminished over time, in general it does not affect normal handset use.

### Battery talk time

When fully charged, the new battery provides approximately 12 hours of talk time. You might need to charge the battery before the first use to achieve the full talk time. To prevent damage to the battery, the protection system does not allow the battery to discharge below a certain point. Avaya Vantage™ displays the battery charge level on the Notifications panel.

### Battery standby time

When fully charged, the new battery provides approximately 60 hours of standby time. When the handset is not in range or Avaya Vantage™ is turned off for approximately 22 minutes, the handset is turned off automatically to save battery. To turn on the handset again, press the **Power** button for approximately 2 seconds. The handset is not turned on automatically even if it is returned to the cradle.

### Battery charging

The handset supports a contactless charging system. To charge the handset, place it in its cradle. If the battery charge is low, the handset will notify you with warning tones. When you hear the warning tones, return the handset to its cradle to charge the battery.

The handset uses a Lithium-Ion battery with the battery management and protection system. The protection system allows to prevent the following situations:

- Overcharging.
- Over-discharging.

- Charging if the ambient temperature is higher than 40 °C (102 °F).

### Battery recharge time

The battery fully recharges in less than 3 hours. You do not need to fully discharge the battery before charging.

### Battery disposal

At the end of the service life, remove the battery and deliver it to a battery recycling depot. Do not dispose of the battery in the normal waste stream.

## Wireless handset LED indicator

The blue LED indicator shows the current state of the handset and is also used to indicate user actions.

Wireless handset state	LED indication	Notes
Wireless handset is in the Pairing mode.	LED flashes every 0.5 seconds.	Wireless handset exits the Pairing mode in 150 seconds.
Pairing completed successfully.	LED flashes 10 times at 0.1 seconds rate.	None
Wireless handset is used in a call	LED flashes 3 times every 3 seconds	None
Wireless handset is turned on and is connected to its base (Connected mode).	LED flashes 2 times every 5 seconds.	None
Wireless handset is trying to establish connection to its base (Linkback mode).	LED flashes every 0.5 seconds.	None
Wireless handset is out of range and is not trying to establish connection to its base (Standby mode).	LED flashes every 5 seconds.	Wireless handset is turned off after 22 minutes.
Incoming call.	LED flashes 3 times every 7 seconds.	None
Mute.	LED is on and flashes 3 times every 4 seconds.	None
Wireless handset has been turned on.	LED flashes 4 times.	None
Wireless handset has been turned off.	LED flashes 3 times.	None

---

## Third party applications

You can install third party applications on Google Play™. The system administrator determines the list of applications that you are allowed to install.

---

## New in this release

Avaya Vantage™ Release 2.0 introduces the K155 device. This device includes a 5-inch screen and a key pad. Currently, only Avaya Vantage™ Basic is supported on the K155 device.

# Chapter 3: Getting started with Avaya Vantage™

This chapter describes general startup tasks, such as logging in or out, locking your Avaya Vantage™ device, and enabling the Avaya Smart Lock feature. To enable the Avaya Smart Lock feature, you must first log in to your device manually.

---

## Installing applications from Google Play Store on K165 and K175

### About this task

Use this procedure to install applications on K165 and K175 devices from Google Play Store.

You can also install Avaya Vantage™ Basic, Avaya Equinox®, or Avaya Vantage™ Open from Google Play Store if these applications are not preinstalled by your administrator.

### Before you begin

- Ensure that you have a Google account to access Google Play Store.
- Your installation policy might prevent you from installing certain applications. Get permission from your administrator to install applications on your Avaya Vantage™ device.

### Procedure

1. On your device, open Google Play Store.
2. In the **Search** bar, enter the appropriate search term and then tap .  
For example, to find Avaya Vantage™ Basic, enter `Avaya Vantage Basic`.
3. From the displayed search results, open the application page.
4. Install the application.
5. **(Optional)** If you want to set the installed telephony application as your primary telephony application, contact your administrator.

Some Avaya applications, such as Avaya Vantage™ Basic or Avaya Equinox®, require additional setup performed by your administrator. Contact your administrator to see if the installed application requires additional setup.

---

## Installing applications on K155

### About this task

Use this procedure to install third-party applications from community-maintained application stores for the Android platform. When installation from unknown sources is enabled, K155 provides an application that displays links to common third-party application stores, such as F-Droid and GetJar. These stores contain Android Package Kits (APKs) of free and open source software applications that you can download to your Avaya Vantage™ device.

You can also install application APKs through other sources, such as email, a web browser, or a USB pen drive. If enabled, you can install third-party applications from unknown sources on all variants of Avaya Vantage™.

### Before you begin

Ensure that the **Unknown sources** option is enabled in **Settings > Security**. If you cannot modify this setting, contact your administrator for assistance.

### Procedure

1. On the Home screen, tap **Applications**.
2. Open **Application Stores Links** (🛒).
3. On the Stores page, tap an application store link.
4. Use the information provided on the application store website to search for and download an application APK.

---

## Logging in to and out of Avaya Vantage™

### About this task

Use this procedure to log in to the Avaya Vantage™ device manually. You can log in to the device by using either SIP or Avaya Aura® Device Services credentials.

After the first login, you can activate the Avaya Smart Lock feature. The Avaya Vantage™ device then automatically logs you in when you are within the range of the device while carrying a trusted device.

### \* Note:

This procedure is only applicable to Avaya Vantage™ Basic and Avaya Equinox®, but not to other telephony applications, such as Avaya Vantage™ Open.

### Procedure

- To log in, do the following:
  1. In **Username**, enter your SIP or Avaya Aura® Device Services user name.  
In an IP Office environment, you must enter your SIP extension number.



2. In **Password**, enter your user password.
3. Tap **Login**.

If you are using Avaya Aura® Device Services credentials, you might also need to enter your SIP credentials.

4. **(Optional)** At the first login, accept the software license agreement.

Avaya Vantage™ displays the Home screen or the main screen of the active telephony application depending on the settings configured by your system administrator.

- To log out, do one of the following:
  - Swipe down to open the notification area, and tap **Logout** (🔒).
  - On the Home screen, tap **Logout** (🔒).
  - In **Settings**, tap **Logout**.

#### Related links

[Enabling Avaya Smart Lock](#) on page 19

---

## Locking and unlocking Avaya Vantage™

### About this task

Use this procedure to lock and unlock the Avaya Vantage™ device manually. You can lock the device for security and privacy reasons. Locking your phone does not log you out, so you can continue to receive calls.

You can activate the Screen Lock feature so that the device is locked automatically after a period of inactivity. With IP Office deployments, this feature is disabled by default, but an administrator can enable it in the settings file.

You can also activate the Avaya Smart Lock feature. The Avaya Vantage™ device then automatically unlocks when you are within the range of the device while carrying a trusted Bluetooth device. When the trusted device goes out of range, the Avaya Vantage™ device is locked automatically.

#### \* **Note:**

This procedure is only applicable to Avaya Vantage™ Basic and Avaya Equinox®, but not for other telephony applications, such as Avaya Vantage™ Open.

### Procedure

- To lock the device, do one of the following:
  - Swipe down to open the notification area, and tap **Lock** (🔒).
  - On the Home screen, tap **Lock** (🔒).

- To unlock the device, do the following:
  1. On the locked screen, swipe up to open the login prompt.
  2. In the **Enter Password** field, enter your SIP or Avaya Aura® Device Services password.
    - If login is performed using SIP credentials, enter the SIP password.
    - If login is performed using Avaya Aura® Device Services credentials, enter the Avaya Aura® Device Services password.
  3. Tap .

When the device is unlocked successfully, Avaya Vantage™ displays the Home screen or the main screen of the active telephony application depending on the settings configured by your system administrator.

#### Related links

[Enabling Avaya Smart Lock](#) on page 19

---

## Avaya Smart Lock

When Avaya Smart Lock is enabled, the Avaya Vantage™ device can automatically get unlocked and log you in without the need to enter your account credentials. The automatic login or unlock happens based on the proximity of the device to a trusted Bluetooth device. When the trusted device goes out of range, the Avaya Vantage™ device is locked automatically, and if configured, you are automatically logged out of the device.

Avaya Vantage™ can stay unlocked whenever it is connected to a trusted device.

### Bluetooth device as the trusted device

You can choose any Bluetooth device, such as Bluetooth headsets, watches, or Bluetooth-enabled Android smart phones, as the trusted device. However, you cannot select the Avaya Vantage™ wireless Bluetooth handset as the trusted device. When choosing your trusted device, avoid using a device that is always with your Avaya Vantage™ device. For example, if you always have a Bluetooth keyboard and mouse with Avaya Vantage™, do not use this as your trusted device.

#### **Note:**

Only one device can be set as the trusted device.

### Bluetooth connectivity range

The Bluetooth connectivity range can vary based on factors, such as your device model, the Bluetooth device, and the current environment. Bluetooth connectivity of the Avaya Vantage™ device can be up to 10 meters.

### Avaya Smart Lock vs. Google Smart Lock

- Avaya Smart Lock can automatically log you in or out of the Avaya Vantage™ device. Google Smart Lock does not support this capability.

- Google Smart Lock does not support an Android smart phone as the trusted device.

---

## Enabling Avaya Smart Lock

### About this task

Use this procedure to enable the Avaya Smart Lock feature. You can set your Avaya Vantage™ device to automatically unlock in certain circumstances, so you do not need to manually unlock the device with your PIN or password.

### Before you begin

- Ensure that the Screen Lock feature is enabled.
- On the Avaya Vantage™ device, turn on Bluetooth.
- Pair a Bluetooth device to use as your trusted device.

### Procedure

To enable the Avaya Smart Lock feature, do the following:

1. Open the **Settings** menu.
2. Tap **Security > Trust agents**.
3. Turn on **Avaya Smart Lock** and tap **Back** (←).

By default, Google Smart Lock is enabled on Avaya Vantage™. Since you can enable only one trust agent at a time, Google Smart Lock is disabled automatically when you enable Avaya Smart Lock.

To set up automatic unlock options and add the trusted device, do the following:

4. Tap **Security > Avaya Smart Lock**.
5. Enter the password that you use to log in and unlock Avaya Vantage™.
6. In the **Avaya Smart Lock** menu, select one of the following lock options:
  - **Unlock/Lock:** When the trusted device is within range, the Avaya Vantage™ device unlocks automatically. When the trusted device goes out of range, the Avaya Vantage™ device is locked automatically.
  - **Login and Unlock/Logout:** When the trusted device is within the range, the Avaya Vantage™ device unlocks, and if required, logs you in automatically. When the trusted device goes out of range, the Avaya Vantage™ device is locked and you are automatically logged out of the device.

After a logout, another user can log in to the device. When a new user logs in, all previous user data is wiped.

7. Tap **Trust Device**.
8. On the list of paired and connected devices, tap the device that you want to select as the trusted device.

On the Lock screen, you see the **Lock** (🔒) icon with a pulsing circle at the bottom. The 🔒 icon indicates that the device is unlocked. When the trusted device is within range, the device remains unlocked until you manually lock it.

To access the device Home screen from the Lock screen, do the following:

9. Swipe up the 🔒 icon.

You see the 🔒 icon only when Smart Lock is set up and the trusted device is within range.

---

## Removing or changing the trusted device

### Procedure

1. Open the **Settings** menu.
2. Tap **Security > Avaya Smart Lock**.
3. Enter the password that you use to log in and unlock Avaya Vantage™.
4. Tap **Trust Device**.
5. On the list of paired and connected devices, do one of the following:
  - To select a new device as the trusted device, tap the device name.
  - To remove the trusted device, tap **None**.

---

## Locking the device manually when Smart Lock is enabled

### About this task

Use this procedure to manually lock your Avaya Vantage™ device when Avaya Smart Lock is set up and the trusted device is within range.

When the trusted device is within range, tapping **Lock** (🔒) from the Home screen or from the notification area does not lock the device. The device displays the Lock screen with the **Lock** (🔒) icon.

### Procedure

On the Lock screen, tap the **Lock** (🔒) icon.

The device stays locked until you manually unlock it with your account password.

---

## Connecting a wireless handset

### About this task

Use this procedure to connect or pair a wireless handset with your Avaya Vantage™ device. You cannot use the wired handset after you connect the wireless handset. You can connect only one wireless handset at a time.

You need administrative privilege to remove the pairing with the wireless handset.

### Before you begin

Ensure the following:

- The device startup process is complete and you are logged on to the device.
- The handset battery is charged by placing the handset in the cradle.
- The wireless handset is turned off.

### Procedure

1. Lift the wireless handset from the cradle, and press and hold the top **Power** button for at least 10 seconds to enter the pairing mode.



To indicate that the handset is in the pairing mode, the handset LED starts flashing.

2. On the Home screen, tap **Applications**.
3. Tap **Settings**.
4. Tap **Bluetooth**.

5. Turn Bluetooth on.
6. In the list of available devices, tap the entry that matches the ID on the handset label.

When pairing is successful, Avaya Vantage™ displays the wireless handset in the list of paired devices as connected.

### **Result**

You can now use your wireless handset for calls as long as the handset is turned on. When the handset is turned off, you cannot use it for calls, but it is still paired with Avaya Vantage™. When you turn on the handset the next time, you do not need to repeat the pairing procedure.

---

## **Turning the wireless handset on and off**

### **About this task**

Your system administrator might connect an optional wireless handset to your Avaya Vantage™. To use the handset, you must turn it on.

When the handset is turned on, the handset LED flashes every 5 seconds. When the handset is not being used on a call and is not in its cradle, it automatically turns off in 60 seconds.

### **Procedure**

To turn the wireless handset on or off, press the **Power** button for approximately 3 seconds.

- When the handset turns on, the handset LED flashes 4 times.
- When the handset turns off, the handset LED flashes 3 times.

# Chapter 4: Navigation

---

## Physical device layout

You can choose from the following Avaya Vantage™ device variants:

- Avaya Vantage™ K175: Standard device with an 8-inch screen and an integrated camera for full access to video calls and conferences. You can cover the camera by using a mechanical camera shutter.
- Avaya Vantage™ K165: Standard device with an 8-inch screen that does not include an integrated camera. You can still receive video from other users.
- Avaya Vantage™ K155: Device with a small 5-inch screen. The device also includes a physical keypad and an integrated camera.

---

## Layout of Avaya Vantage™ K165 and K175

The standard Avaya Vantage™ device resembles a tablet in the portrait orientation. The only difference in the layout of the Avaya Vantage™ K165 and K175 variants is that K175 comes with an integrated camera and a mechanical camera shutter.

# Navigation





## Layout of Avaya Vantage™ K155



### Functional keys on the keypad

The Avaya Vantage™ K155 device includes a physical keypad.

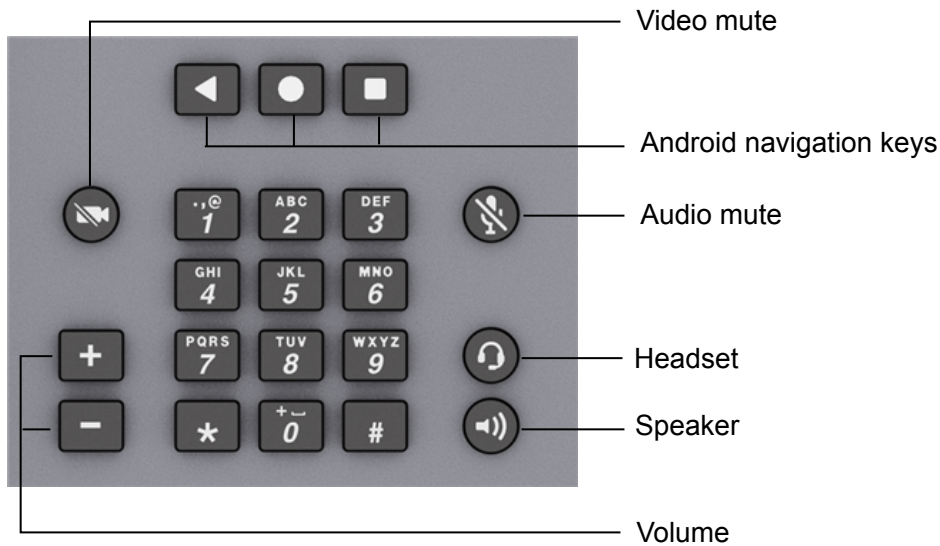

## Connectors and controls

The following images show the options available on the Avaya Vantage™ device.

### Rear panel

The rear panel contains a power adapter connector, an RJ9 headset port, and dual Ethernet ports with an internal Ethernet switch.

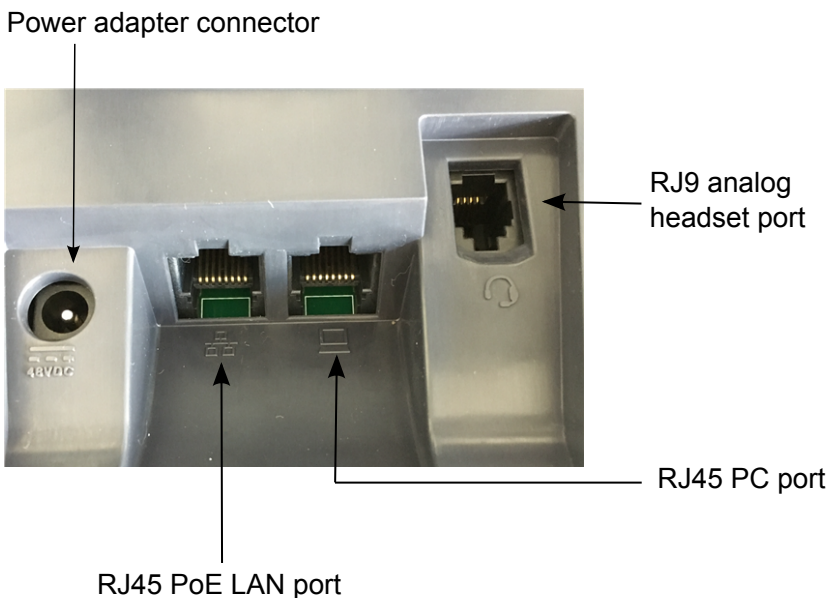

**\* Note:**

Avaya Vantage™ K165 and K175 devices from Release 1.0 only have a single Ethernet port. Devices with hardware version 5 and later support dual Ethernet ports with an internal Ethernet switch.

The K155 device has dual Ethernet ports with an internal Ethernet switch.

K155 devices have an additional wireless module slot in the top-right of the rear panel. The wireless module provides Wi-Fi and Bluetooth connectivity.



Slot for wireless module

**Right side panel**

On Avaya Vantage™ K165 and K175, the right side panel contains a 3.5 mm audio jack socket and a USB Type-C port.

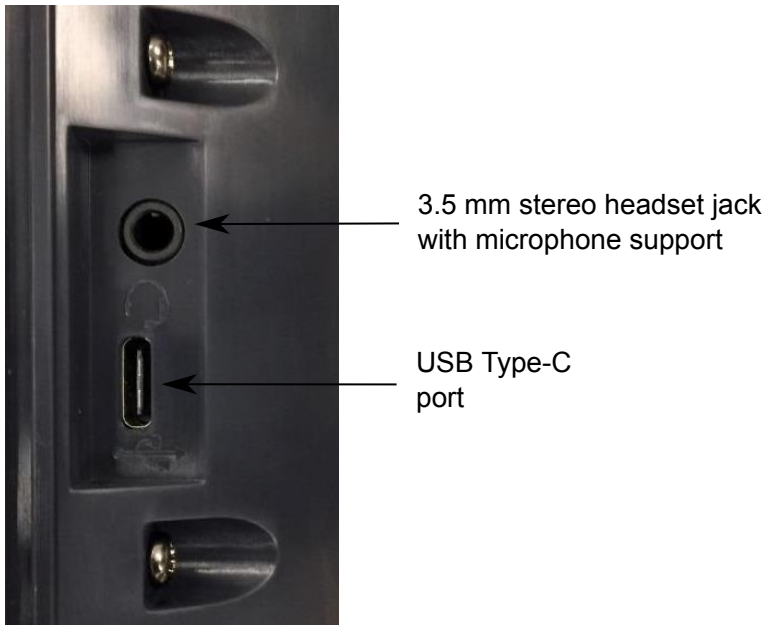

On Avaya Vantage™ K155, the right side panel contains a 3.5 mm audio jack socket and a USB Type-A port.

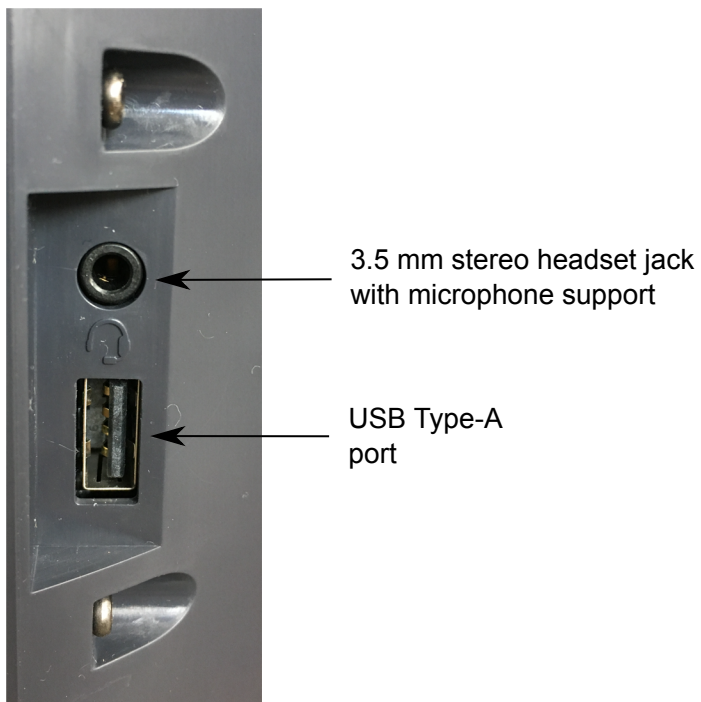

## Left side panel

On all device variants, the left side panel contains a cordless or corded handset cradle connector.

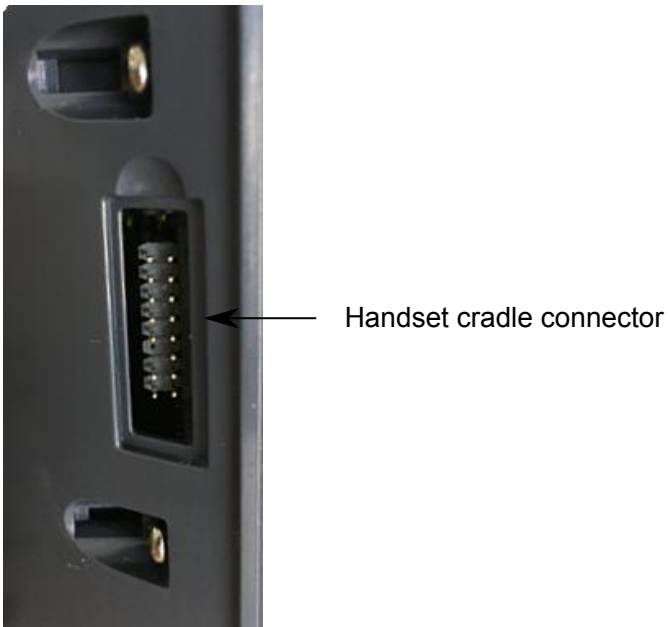

---

## Wireless handset layout

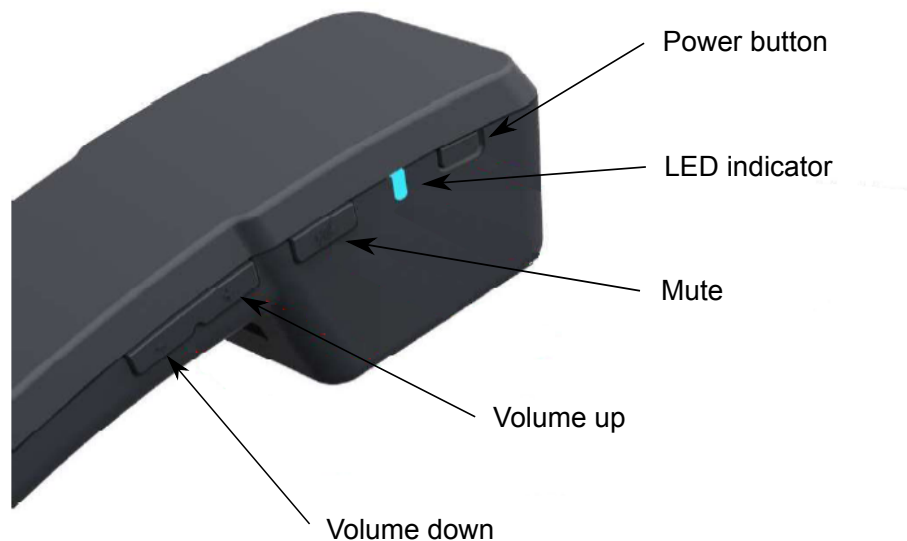

---

## Avaya Vantage Basic screen navigation

---

### Dial pad screen

The following sections show the Avaya Vantage™ Basic Dial pad screen.

K165 or K175 device

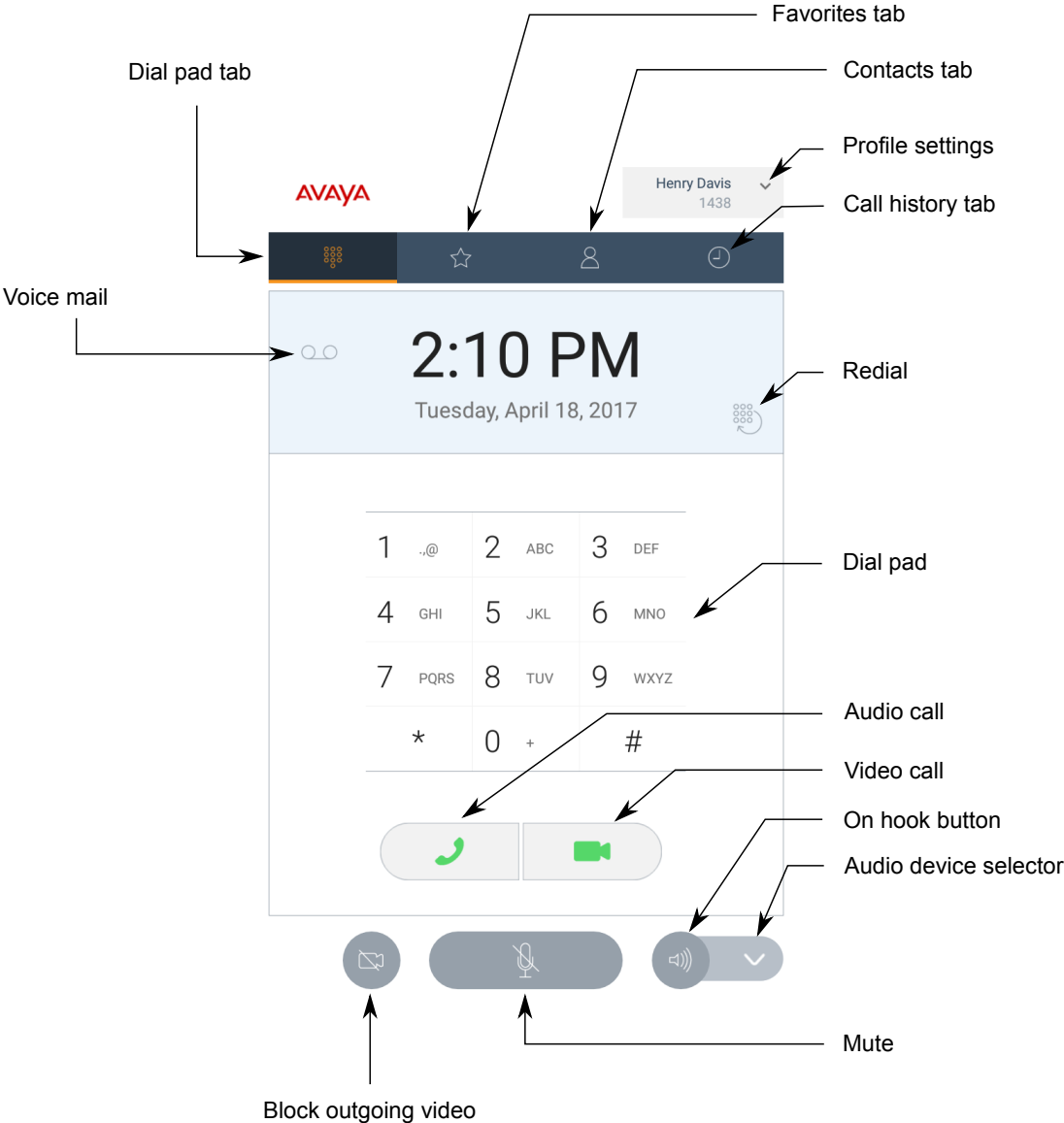

### K155 device

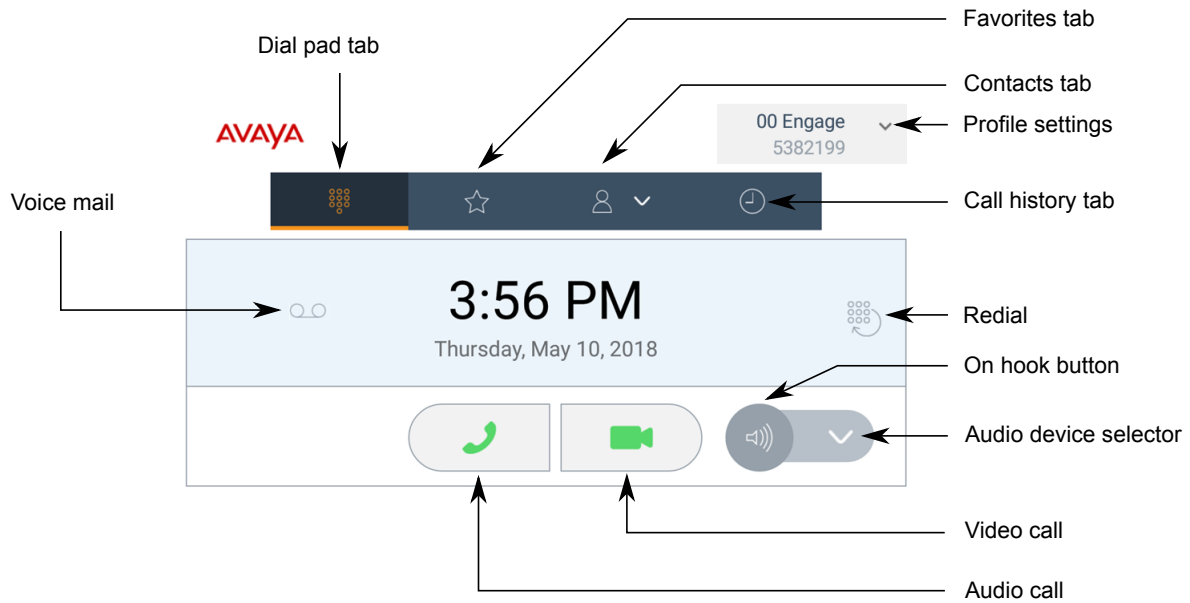

---

## Contacts screen

The following sections show the Avaya Vantage™ Basic Contacts screen.



K165 or K175 device



### K155 device

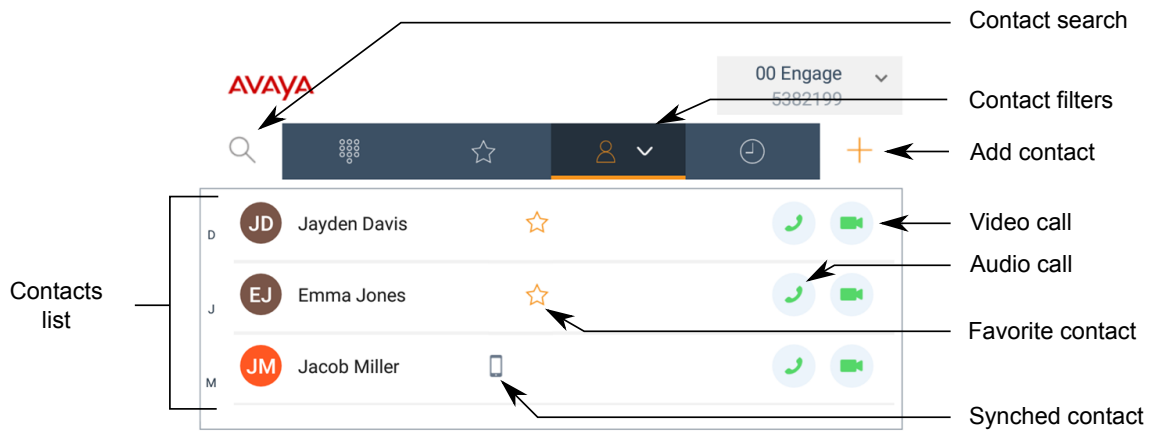

---

## Call screen

The following sections show the Avaya Vantage™ Basic Call screen.

K165 or K175 device

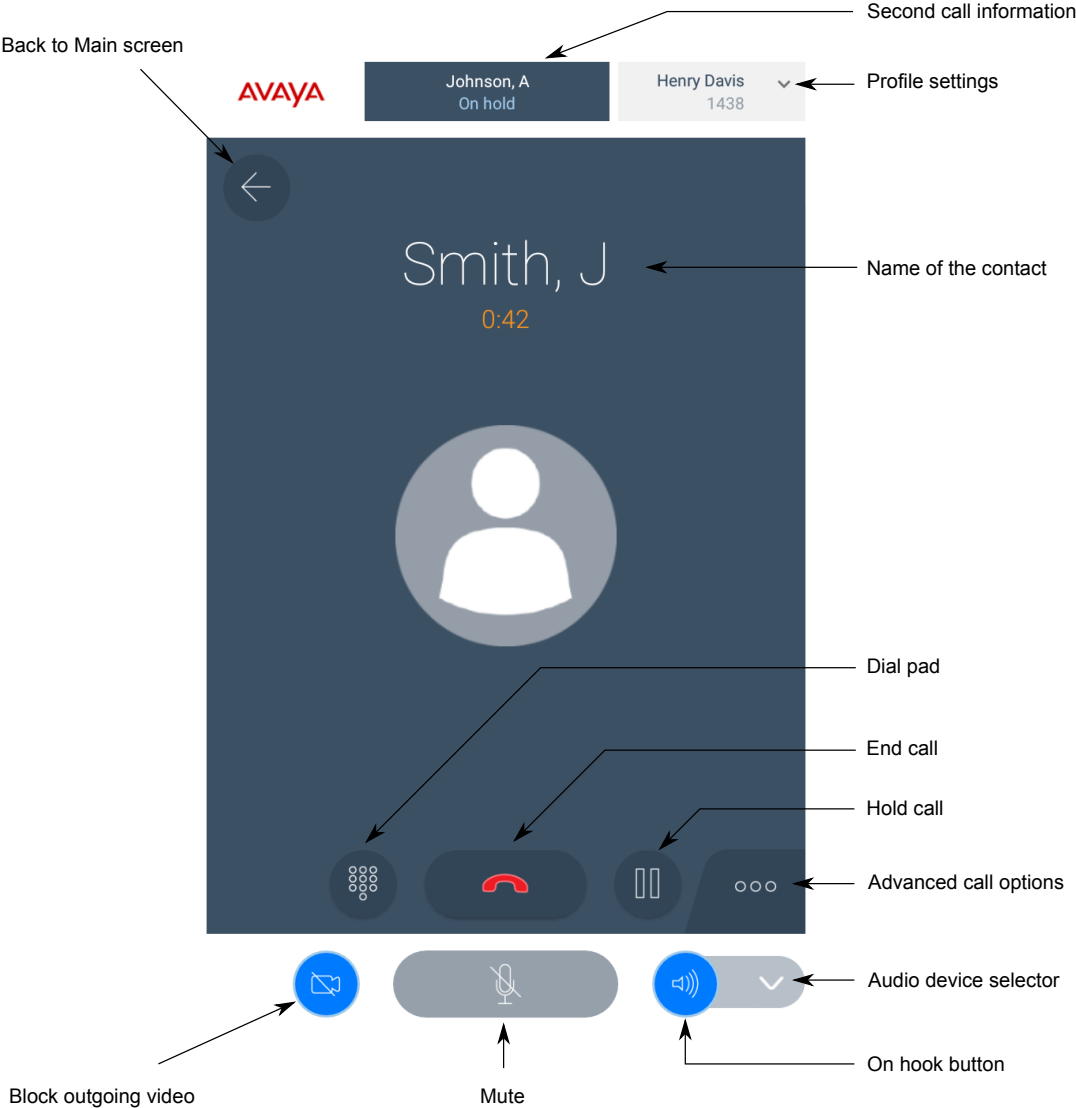

### K155 device

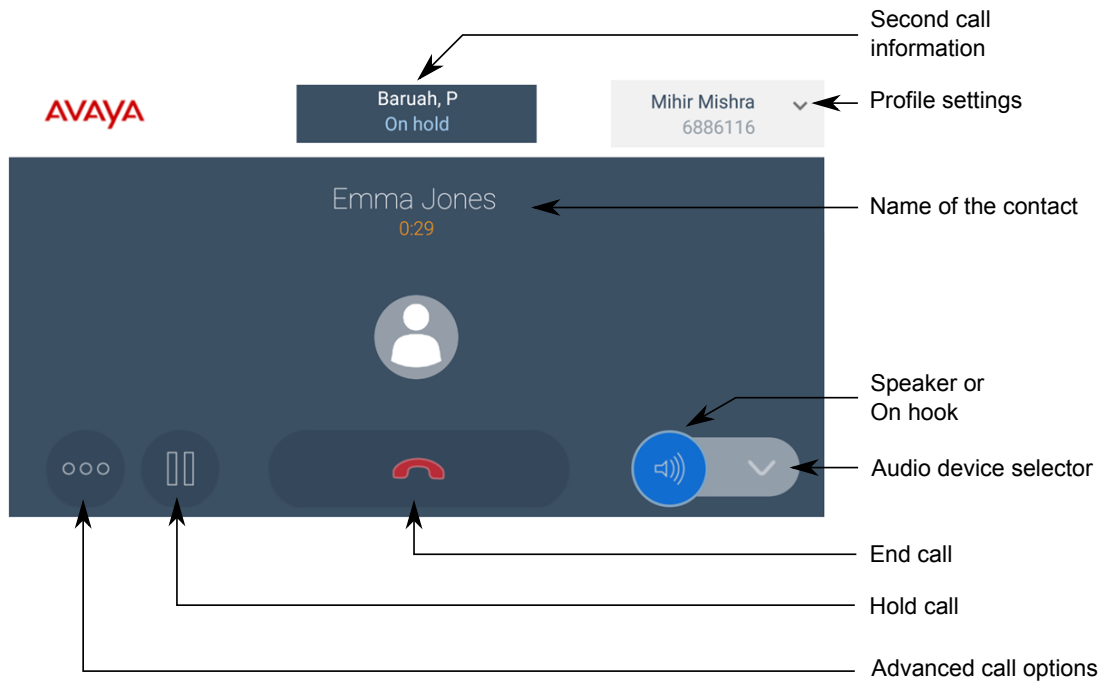

# Chapter 5: Call management operations

You can perform the following key call management tasks:

- Making audio or video calls
- Answering audio or video calls
- Performing call control operations
- Viewing your call history and missed calls
- Working with conferences

---

## Making audio or video calls

---

### Making an emergency call

#### About this task

Use this procedure to make a call to a preconfigured emergency services number. Your system administrator can configure the emergency services numbers.

In the Avaya Aura® environment, you can make an emergency call even when you are logged out of Avaya Vantage™ or when Avaya Vantage™ is in the locked state.

In the IP Office environment, you can make an emergency call only when you are logged in to Avaya Vantage™. You can make an emergency call from a locked device if the Lock mode is enabled and an administrator has configured emergency numbers in the `46xxspecials.txt` file.

#### Procedure

- To make an emergency call from the Login screen or the Lock screen, in the lower-right corner of the screen, tap **Emergency call** and do one of the following:
  - To automatically dial the preconfigured emergency number with the highest priority, tap **Auto - dial**.
  - To dial one of preconfigured emergency numbers manually, tap **Manual dial**, enter the number and then tap .

On K165 and K175, you must tap the digits on the screen. On K155, use the physical keypad on the device.

- To make an emergency call from Avaya Vantage™ Basic, on the Dial pad screen, enter the emergency number and then tap .

On K165 and K175, you must tap the digits on the screen. On K155, use the physical keypad on the device.

---



## Making an audio or video call by using the dial pad

### Procedure

1. Tap the **Dial pad** tab.
2. Enter the telephone number that you want to call.

On K165 and K175, you must tap the digits on the screen. On K155, use the physical keypad on the device.

3. Tap one of the following:

- : To make an audio call.
- : To make a video call.

4. **(Optional)** To use the handset for the audio, lift the handset from the cradle.



If you lift the handset before dialing the phone number, then the option to choose between an audio or video call becomes unavailable. An audio call starts automatically after you dial the number.

---

## Making an audio or video call using contacts

### Procedure

1. Tap the **Contacts** tab.
2. Select the required contact.
3. Tap one of the following:

- : To make an audio call.
- : To make a video call.

---

## Making an audio or video call from your Favorites list



### Before you begin

Ensure that you have contacts in your Favorites list.

#### **Note:**



On IP Office, you cannot add IP Office personal contacts to your Favorites list.

## Procedure

1. Tap the **Favorites** tab.
2. Select the required contact.
3. Tap one of the following:
  - : To make an audio call.
  - : To make a video call.

## Making an audio or video call using call history

### Procedure

1. Tap the **Call History** tab.
2. Select the required contact or telephone number.
3. Tap one of the following:
  - : To make an audio call.
  - : To make a video call.

## Making a second call

### About this task



Use this procedure to make a second call while you are already on a call. You can have up to two calls at the same time. When one call is active, the other is placed on hold.

### **Note:**

For multiple line support to work on IP Office, you must enable the Call Waiting On feature for the user account. Otherwise the connection is treated as a single line.

### Procedure

1. While on a call, tap .
2. In the Call Features window, tap **New Call**.  
Avaya Vantage™ Basic places the first call on hold and displays the Dial pad screen.
3. Do one of the following:
  - Enter the telephone number you want to call.  
On K165 and K175, you must tap the digits on the screen. On K155, use the physical keypad on the device.
  - In the **Contacts** tab, select the required contact.

- In the **Favorites** tab, select the required contact.
  - In the **Call History** tab, select the required contact or telephone number.
4. Tap one of the following:
- : To make an audio call.
  - : To make a video call.

After the connection is established, the second call becomes the active call. The first call remains on hold until you toggle between calls.





---

## Redialing a number

### About this task

Use this procedure to redial the last dialed number.

### Procedure

1. On the Dial pad screen, tap .  
Avaya Vantage™ displays the last dialed number on the screen.
  2. Tap one of the following:
    - : To make an audio call.
    - : To make a video call.
- You can also redial by double tapping  or .

---



## Managing calls

---

### Answering, declining, or ignoring an incoming call



#### Procedure

- To answer an audio call, do one of the following:
  - Tap  on your screen.
  - Lift the handset from the cradle when you are using a wired or wireless handset.

On K155, after answering the call, you can also use the  and  buttons on the device to toggle between your headset or speaker phone.

- To accept a video call, tap .



- To decline a call, tap .
  - To ignore a call, do one of the following:
    - Press and hold the **Volume down** button until the volume is down to zero and the Do Not Disturb (DND) mode is on with *Alarms only* interruptions.
    - Swipe down to open the notification area, and tap **Do not disturb** (.
- The device mutes interruptions other than alarms.
- You can turn off DND by tapping **Alarms only** () in the notification area.

---

## Entering digits during a call

### About this task

Use this procedure to enter DTMF digits during a call. For example, when you check your voice mail, you are prompted to enter digits.

### Procedure

- On K165 and K175, do the following:
    1. While on an active call, tap .

The application displays the dial pad.

    2. Enter the required digits.
  - On K155, use the physical keypad on the device to enter the required digits.
- The application does not display the entered digits on the screen.

---



## Muting or unmuting a call



### About this task

Use this procedure to mute or unmute your microphone during an active call. When you are on mute, the other party cannot hear you.

A muted call gets unmuted automatically when you switch to a different audio device during the call. However, you can perform call operations, such as putting the call on hold or resuming the call, during a muted call without getting unmuted.

### Procedure

- To mute yourself during a call:
  - On K165 or K175, tap  on the screen.
  - On K155, press the  button on the device keypad.

- To unmute yourself:
  - On K165 or K175, tap .
  - On K155, press the  button on the device again.
- **(Optional)** On a wireless handset, press the **Mute** button to mute or unmute yourself.



When you mute a call on your wireless handset, the application UI does not indicate that the call is muted.

If you disconnect the call without unmuting the wireless handset, the handset remains muted.

---

## Placing a call on hold and resuming the call

### Procedure

- To place a call on hold, tap .
- To resume the call, tap .

---

## Toggleing between calls

### About this task

Use this procedure to toggle between two calls when one call is active and the other call is on hold.

#### **Note:**

For multiple line support to work on IP Office, you must enable the Call Waiting On feature for the user account. Otherwise the connection is treated as a single line.

### Procedure

1. At the top of the Call screen, tap the label of the held call.

The application displays the inactive or held call on the Call screen.

2. Tap .

The inactive call becomes the active call, and the other call is placed on hold.



---

## Transferring a call

### About this task

Use this procedure to transfer a call to another number. A direct transfer, as described in this procedure, is a blind or unattended transfer. When you perform a blind transfer, you cannot notify the other party about the transfer and you cannot return to your original call after starting the transfer procedure.

## Procedure

1. During an active call, tap .
2. Tap .
3. Do one of the following:
  - Tap **Enter a number** and then enter the phone number.
  - Tap **Choose a Person** and then select the required contact from the Contacts, Call History, or Favorites list.
4. Tap **Transfer**.

---



## Working with video functionality

### About this task

Use this procedure to start, stop, pause, and resume the video during a call. When you pause the video, the application stops transmitting your video to the other party. But you can still receive video from the other party, and your audio is still transmitted to the other party.

- When you switch to another application while on a video call, the video is stopped. To restart the video, switch back to Avaya Vantage™ Basic.
- When the other party makes a video call or adds video to an existing call, Avaya Vantage™ Basic always pauses the outgoing video for privacy reasons. To transmit your video to the other party, you must enable video manually.

### Procedure

- To start or stop video, tap  and then tap **Start Video** or **Stop Video**.
- To pause or mute video on K165 or K175:
  1. Tap .
 

The icon becomes blue.
  2. **(Optional)** To resume the video, tap the icon again.
- To pause or mute video on K155:
  1. Press .
  2. **(Optional)** To resume the video, press the button again.

---



## Selecting the audio device

### About this task

Use this procedure to select the audio device to be used in a call.

By default, Avaya Vantage™ uses speakers to transmit audio. If you have a headset or handset connected to your device, you can select which audio device to use in a call.

## Procedure

- To select the audio device from the Dial pad or Call screen, tap  and select from the list of audio devices.
- To select the handset as the active audio device during a call, lift the handset from the cradle. Avaya Vantage™ automatically transfers audio to the handset.
- To transfer audio from the handset to the device speaker during a call, do the following:
  1. Tap  and tap **Speaker**.  
Avaya Vantage™ transfers audio to the speaker.
  2. Place the handset on its cradle.

---



## Ending a call

### About this task

Use this procedure to end an active call.

If you receive a call while on another call, you cannot end the first call until you answer or decline the second call.

### Procedure

- Tap  on the screen.
- If you are using the speaker phone, tap .
- If you are using a handset, do one of the following:
  - Hang up by placing the handset in its cradle.
  - Tap .



---

## Viewing call history

### Procedure

1. Tap the **Call History** tab.
2. Filter the call history using the following options:
  - **All Calls**
  - **Missed Calls**
  - **Outgoing Calls**
  - **Incoming Calls**

3. **(Optional)** To view the call history of the synchronized device:

- On K165 or K175, tap , which is at the top-right side of the contacts list.
- On K155, in the filter options drop-down (), tap **Bluetooth Sync**.

Avaya Vantage™ Basic displays the call history of the synchronized mobile device in the Call History tab if:

- Call history sharing is enabled.
- The paired mobile device is connected with Avaya Vantage™.

#### Related links

[Synchronizing contacts and call history over Bluetooth](#) on page 50

---

## Deleting all call information

### Procedure

1. Tap the **Call history** tab.
2. Filter the call history and select **Clear All Calls**.
3. Tap **Delete** in the Confirmation dialog box.

---

## Working with conference calls

---

### Starting a conference call

#### About this task

Use this procedure to start an audio or video conference call.

#### Important:

This procedure does not apply to IP Office deployments. With IP Office, you can only merge calls to create a conference call. Video conference is also not supported with IP Office.

#### Procedure

1. During an active call, tap .
2. In the Call Features window, tap **Add Someone**.
3. Do one of the following:
  - Tap **Enter a number** and then enter the phone number.
  - Tap **Choose a Person** and then select the required contact from the Contacts, Call History, or Favorites list.

4. Tap **Add Someone**.

A call is placed to the selected participant. When the participant answers, the conference starts.



---

## Merging calls to create a conference call

### Before you begin

You must have two ongoing calls.

### Procedure

1. On the Call screen, tap .
2. Tap  to merge both calls into a conference call.

# Chapter 6: Contact management operations

---

## Adding a contact

### About this task

Use this procedure to add new contacts to Avaya Vantage™ Basic. You can save a personal contact in the local storage or to the enterprise directory. In the IP Office environment, you can add a personal contact to the IP Office personal directory.

In Avaya Vantage™ Basic, you can modify and delete personal contacts added to the enterprise or IP Office personal directory. Any modification to such contacts is synchronized automatically between Avaya Vantage™ Basic and the enterprise or IP Office personal directory.

Note that Avaya Vantage™ deletes local contacts data when another user logs in to the device. To store local contacts data, enable data backup and provide a backup account in the **Settings** menu.

### Procedure

1. Tap the **Contacts** tab.
2. Tap **+**.
3. Choose one of the following:
  - **Local Contact:** To store the contact locally on the device.
  - **Enterprise Contact:** To add the contact to the Avaya Aura® enterprise directory.
  - **Personal Contact:** To add the contact to the IP Office personal directory.

Either the **Enterprise Contact** or the **Personal Contact** option is available depending on the environment in which the device is installed.

4. In the **First Name** and **Last Name** fields, enter the name of the new contact.
5. Do the following to add the phone number of the contact:
  - a. Tap **Add phone number**.
  - b. In the drop-down list, select the appropriate phone category.
  - c. In the **Phone** field, enter the phone number.

You must provide at least one phone number for each contact.

Use the on-screen keyboard to enter contact details. Do not use the physical keypad on the K155 device.

6. **(Optional)** Repeat Step 5 to add more phone numbers for the contact.
7. **(Optional)** Add other information about the contact, such as the job title, company name, and address.
8. Tap **Done**.

The application displays the new contacts and their details in the Contacts list.

---

## Editing a contact

### About this task

Use this procedure to edit the details of a contact.

You can modify local contacts and personal contacts added to the enterprise or IP Office personal directory. Any modification to personal contacts is synchronized automatically between Avaya Vantage™ Basic and the enterprise or IP Office personal directory.

### Procedure

1. Tap the **Contacts** tab.
2. In the contacts list, tap the contact that you want to edit.
3. On the Contact Details page, tap **Edit**.
4. Tap the field that you want to edit.
5. Use the on-screen keyboard to modify the information.
6. Tap **Done**.

---

## Deleting a contact

### About this task

Use this procedure to delete a contact from the contacts list.

You can delete local contacts and personal contacts added to the Avaya Aura® enterprise or IP Office personal directory.

### Procedure

1. Tap the **Contacts** tab.
2. In the contacts list, tap the contact that you want to delete.
3. On the Contact Details page, tap **Delete**.
4. Tap **Yes** to confirm the action.



---

## Searching for a contact

### About this task

Use this procedure to search for a contact.

In the IP Office environment, IP Office system contacts are only visible through a search.

### Procedure

1. Tap the **Contacts** tab.
2. On K155, tap the  icon.
3. In the **Search** field, start typing the name of the contact that you want to look for.

The application displays all relevant contacts.

---

## IP Office contact search options

In the IP Office environment, Avaya Vantage™ Basic and the standard Contacts application () available on the Avaya Vantage™ device support a centralized IP Office directory contact search, which includes the following:

- IP Office system contacts and hunt group contacts across a small community network (SCN)
- External contacts in the LDAP, system, and HTTP directories configured on IP Office

---

## Saving an IP Office system contact as a personal contact

### About this task

IP Office system contacts are only visible through a search. Use this procedure to find a system contact and save the contact to your IP Office personal directory.

### Procedure

1. In the **Search** field, start typing the name of the system contact.
2. Select the contact from the list that is displayed.
3. Click **Create contact**.

Avaya Vantage™ automatically populates the contact with the name and phone number of the system contact.

4. Click **Done** to save the contact to your IP Office personal directory.

---

## Setting contact display options

### About this task

Use this procedure to modify how contact names are displayed in the Contacts list. Contacts can be displayed with the first name first or with the last name first.

### Procedure

1. In Avaya Vantage™ Basic, tap **Extension > User Settings**.
2. Tap **Application**.
3. In Display preferences, tap **Name display preferences** and then select one of the following options:
  - **First Name First**: To display the contact names with the first name first followed by the last name.
  - **Last Name First**: To display the contact names with the last name first followed by the first name.
4. Tap **Name sort preferences** and then select one of the following options:
  - **First Name First**: To sort the contact list based on the first name.
  - **Last Name First**: To sort the contact list based on the last name.

---

## Setting a contact as a favorite

### About this task

Use this procedure to add a contact to your Favorites list.

In the IP Office environment, you cannot add IP Office personal contacts to your Favorites list.

### Procedure

1. Tap the **Contacts** tab.
2. Tap the appropriate contact.
3. In Contact Details, tap ☆, which is next to the contact's name.

---

## Synchronizing contacts and call history over Bluetooth

### About this task

Use this procedure to synchronize your mobile phone's contacts and call history with the Avaya Vantage™ device over Bluetooth. After the synchronization, you can access the paired phone's contacts and call history on your Avaya Vantage™ device when the devices are connected.

Contacts from all accounts on your mobile phone, including Google and Facebook, are shared with the Avaya Vantage™ device, but only so long as the devices remain connected. If Bluetooth connectivity is lost, the shared phone contacts and call history data is automatically deleted from the Avaya Vantage™ device.

## Procedure

To pair a mobile phone with the Avaya Vantage™ device, do the following:

1. On the mobile phone and the Avaya Vantage™ device, turn on Bluetooth.
2. On the Avaya Vantage™ device, tap **Settings > Bluetooth**.
3. In Available devices, tap the name of the mobile phone.
4. On the screens of both devices, do the following:
  - a. Verify the displayed passcode.
  - b. Select the option to allow the paired device to access the contacts and call history.
  - c. Tap **Pair**.

To synchronize and share contacts and call history from the paired phone, do the following:

5. On the Avaya Vantage™ device, tap **Settings > Bluetooth**.
6. In Bluetooth Contact & Call History Sharing, enable the following:
  - **Contact Sharing**
  - **Call History Sharing**

The synchronized contacts become available through the following:

- The Contacts tab in the Avaya Vantage™ Basic or Avaya Equinox® application.
- The standard Contacts application on the Avaya Vantage™ device.

The synchronized call history is available on the Call History tab of the Avaya Vantage™ Basic application.

### **Note:**



Any third-party application that is capable of displaying call logs from the default telephony application can display the call history for the synchronized mobile device. After the Bluetooth connection is disconnected, if an application is caching the call history and not clearing the cache, the call history from the synchronized device is retained.

---

## Filtering contacts

### Procedure

1. Tap the **Contacts** tab.

2. Filter the contacts using the following options:
  - **All Contacts:** To view the local and enterprise contacts.
  - **Enterprise Contacts:** To view Avaya Aura® enterprise contacts.
  - **Personal Contacts:** To view IP Office personal contacts.
  - **Local Contacts:** To view the contacts stored in the local storage, such as Google or Exchange contacts.
3. **(Optional)** To view the contacts of the synchronized device:
  - On K165 or K175, tap , which is at the top-right side of the contacts list.
  - On K155, in the contact filter drop-down ( ) , tap **Bluetooth Sync**.

Avaya Vantage™ Basic displays the contacts of the synchronized device under All Contacts and Local Contacts if:

- Contact sharing is enabled.
- The paired device is connected with Avaya Vantage™ .

#### Related links

[Synchronizing contacts and call history over Bluetooth](#) on page 50

# Chapter 7: Customization

---

## Modifying the ring tone

### About this task

Use this procedure to change the default ring tone for incoming calls in Avaya Vantage™ Basic. You can select from a list of built-in and administrator-downloaded ring tones.

You can change the ring tone in the telephony application but not on the Avaya Vantage™ device.

### Procedure

1. In Avaya Vantage™ Basic, tap **Extension > User Settings**.
2. Tap **Audio/Video**.
3. In Ring Preferences, tap **Choose Ringtone**.
4. Select the new ring tone and tap **OK**.

---

## Disabling video by using the privacy shutter on a K175 device

### About this task

On the K175 device, you can prevent the camera from capturing video by using a privacy shutter. When you close the shutter, the camera is still on, but it only transmits a black background. The camera LED is also on, indicating that the camera is working.

### \* Note:

Because the K155 device does not include a camera shutter, you can use the  button to disable video.

### Procedure

- Shift the lever located above the camera to the leftmost position so that the camera is entirely covered with the shutter.

If the shutter does not cover the entire camera, the camera might capture partial video.

- To uncover the camera, shift the lever to the rightmost position.

---

## Changing the wallpaper

### About this task

Use this procedure to change the default wallpaper on the Avaya Vantage™ device. You can select an administrator-downloaded wallpaper or any other image file available on the device.

### Procedure

1. Tap **Settings > Display**.
2. Tap **Wallpaper**.
3. Tap one of the following options available on the device:
  - **Live wallpapers**
  - **Photos**
  - **Wallpapers**
4. Select the new wallpaper and tap **Set wallpaper**.

---

## Enabling or disabling the Do Not Disturb mode

### About this task

Use this procedure to enable or disable the Do Not Disturb (DND) mode on the Avaya Vantage™ device. You can use DND to limit sounds from the device when required. When DND is turned on, you can still make or receive calls. The device displays the visual call or other alerts.

### Procedure

- To turn on the DND mode, do the following:
  1. Swipe down to open the notification area, and tap **Do not disturb** (🔕).

The DND mode is on. By default, the device mutes interruptions other than alarms.
  2. **(Optional)** To further customize the kind of interruptions to allow in DND mode, tap one of the following:
    - **Total silence**: To completely mute your device so that it does not make any sounds or vibrate. The device does not make sounds when you get a call or notification. This option also mutes alarms and sounds from music, videos, games, or other media. During a phone call, you can still hear the other person.
    - **Alarms only**: To mute your device except alarms and sounds from music, videos, games, or other media. The device does not make sounds when you get a call or notification.
    - **Priority only**: To mute your device except in case of alarms, reminders, events, and callers that you specify. You can set your priority preferences.

3. **(Optional)** Choose how long you want this DND setting to last.
  4. Tap **Done**.
- To set the notifications that are to be considered priority when DND is on with **Priority only**, do the following:
    1. Swipe down the notification area, and tap **Do not disturb**.
    2. Tap **MORE SETTINGS > Priority only allows**.
    3. Set the following priorities:
      - **Reminders and Events**.
      - **Messages and Calls**. You can choose to get notification for calls or messages from anyone, contacts only, favorite contacts only, or none.
      - **Repeat callers**. You can choose whether to let your device ring if the same person calls again within 15 minutes.

By default, the Alarms priority is always on.

- To turn on the DND mode using the **Volume down**, press and hold the **Volume down** button until the volume is down to zero and **Alarms only** is on.

The device mutes interruptions other than alarms.

- To turn off the DND mode, in the notification area, tap the currently displayed option from the following:
  - **Alarms only** (☹)
  - **Total silence** (☹)
  - **Priority only** (☹)

# Chapter 8: Resources

---

## Documentation

See the following related documents at <http://support.avaya.com> and <http://documentation.avaya.com>.

Title	Use this document to:	Audience
Installing and administering		
<i>Installing and Administering Avaya Vantage™</i>	Install, configure, and maintain Avaya Vantage™.	Implementation personnel
Using		
<i>Using Avaya Equinox® for Android, iOS, Mac, and Windows</i>	Set up and use Avaya Equinox® clients.	<ul style="list-style-type: none"><li>• End users</li><li>• Support personnel</li></ul>
<i>Using Avaya Vantage™ Open</i>	Use Avaya Vantage™	<ul style="list-style-type: none"><li>• End users</li><li>• Support personnel</li></ul>

---

## Finding documents on the Avaya Support website

### Procedure

1. Navigate to <http://support.avaya.com/>.
2. At the top of the screen, type your username and password and click **Login**.
3. Click **Support by Product > Documents**.
4. In **Enter your Product Here**, type the product name and then select the product from the list.
5. In **Choose Release**, select an appropriate release number.
6. In the **Content Type** filter, click a document type, or click **Select All** to see a list of all available documents.

For example, for user guides, click **User Guides** in the **Content Type** filter. The list displays the documents only from the selected category.

7. Click **Enter**.



---

## Avaya Documentation Portal navigation

Customer documentation for some programs is now available on the Avaya Documentation Portal at <http://documentation.avaya.com/>.

### **Important:**

For documents that are not available on the Avaya Documentation Portal, click **Support** on the top menu to open <http://support.avaya.com/>.

Using the Avaya Documentation Portal, you can:

- Search for specific content.

To perform a search:

- Type a keyword in the **Search** field.
  - Type a keyword in **Search**, and select the filters to search for content by product, release, and document type.
  - Select the appropriate product or solution and then select the appropriate item from the list.
- Search for a document from the **Publications** menu.
  - Publish a PDF of the content. You can publish a PDF of the current section only, the section and its subsections, or the entire document.

- Add content to your collection using **My Docs** (☆).

From the **My Content > My Docs** menu, you can:

- Create, rename, and delete a collection.
  - Add content from various documents to a collection.
  - Save a PDF of selected content in a collection and download it to your computer.
  - Share content in a collection with others through email.
  - Receive content that others have shared with you.
- Add yourself as a watcher to the content using the **Watch** icon (👁).

From the **My Content > Watch list** menu, you can:

- Set how frequently you want to be notified, starting from every day to every 60 days.
- Unwatch selected content, all content in a book, or all content on the Watch list page.

As a watcher, you will be notified when content is updated or deleted from a document, or if the document is removed from the portal.

- Share a section on social media platforms, such as Facebook, LinkedIn, Twitter, and GooglePlus.

- Send feedback on a section and rate the content.

**\* Note:**

Some functionality is only available when you log in to the portal. The available functionality depends on the role with which you are logged in.

---

## Viewing Avaya Mentor videos

Avaya Mentor videos provide technical content on how to install, configure, and troubleshoot Avaya products.

### About this task

Videos are available on the Avaya Support website, listed under the video document type, and on the Avaya-run channel on YouTube.

### Procedure

- To find videos on the Avaya Support website, go to <http://support.avaya.com> and perform one of the following actions:
  - In **Search**, type `Avaya Mentor Videos` to see a list of the available videos.
  - In **Search**, type the product name. On the Search Results page, select **Video** in the **Content Type** column on the left.
- To find the Avaya Mentor videos on YouTube, go to [www.youtube.com/AvayaMentor](http://www.youtube.com/AvayaMentor) and perform one of the following actions:
  - Enter a key word or key words in the **Search Channel** to search for a specific product or topic.
  - Scroll down Playlists, and click the name of a topic to see the available list of videos posted on the website.

**\* Note:**

Videos are not available for all products.

---

## Support

Go to the Avaya Support website at <http://support.avaya.com> for the most up-to-date documentation, product notices, and knowledge articles. You can also search for release notes, downloads, and resolutions to issues. Use the online service request system to create a service request. Chat with live agents to get answers to questions, or request an agent to connect you to a support team if an issue requires additional expertise.

---

## Using the Avaya InSite Knowledge Base

The Avaya InSite Knowledge Base is a web-based search engine that provides:

- Up-to-date troubleshooting procedures and technical tips
- Information about service packs
- Access to customer and technical documentation
- Information about training and certification programs
- Links to other pertinent information

If you are an authorized Avaya Partner or a current Avaya customer with a support contract, you can access the Knowledge Base without extra cost. You must have a login account and a valid Sold-To number.

Use the Avaya InSite Knowledge Base for any potential solutions to problems.

1. Go to <http://www.avaya.com/support>.
2. Log on to the Avaya website with a valid Avaya user ID and password.  
The system displays the Avaya Support page.
3. Click **Support by Product > Product Specific Support**.
4. In **Enter Product Name**, enter the product, and press `Enter`.
5. Select the product from the list, and select a release.
6. Click the **Technical Solutions** tab to see articles.
7. Select relevant articles.

# Index

## A

active call	
entering digits .....	<a href="#">41</a>
adding	
system contact as a personal contact .....	<a href="#">49</a>
adding a contact .....	<a href="#">47</a>
answering a call .....	<a href="#">40</a>
Avaya Smart Lock .....	<a href="#">18</a>
enabling .....	<a href="#">19</a>
Avaya Vantage Basic	
installing .....	<a href="#">15</a>
supported features .....	<a href="#">11</a>
Avaya Vantage device layout	
K155 .....	<a href="#">25</a>
K165 and K175 .....	<a href="#">23</a>
Avaya Vantage overview .....	<a href="#">10</a>

## C

call history	
deleting .....	<a href="#">45</a>
viewing .....	<a href="#">44</a>
call management .....	<a href="#">37</a>
calls	
adding video to a call .....	<a href="#">43</a>
answering .....	<a href="#">40</a>
ending .....	<a href="#">44</a>
making a call using a call history .....	<a href="#">39</a>
making a call using contacts .....	<a href="#">38</a>
making a call using dial pad .....	<a href="#">38</a>
making a call using favorites .....	<a href="#">38</a>
making an emergency call .....	<a href="#">37</a>
making a second call .....	<a href="#">39</a>
toggling between calls .....	<a href="#">42</a>
transferring .....	<a href="#">42</a>
call transfer	
unattended transfer .....	<a href="#">42</a>
change history .....	<a href="#">8</a>
changing default ring tone .....	<a href="#">53</a>
changing wallpaper .....	<a href="#">54</a>
collection	
delete .....	<a href="#">57</a>
edit name .....	<a href="#">57</a>
generating PDF .....	<a href="#">57</a>
sharing content .....	<a href="#">57</a>
conference call .....	<a href="#">45</a>
merging calls into a conference .....	<a href="#">46</a>
connecting	
wireless handset .....	<a href="#">21</a>
connectors and controls .....	<a href="#">26</a>
contacts	
adding .....	<a href="#">47</a>

contacts ( <i>continued</i> )	
adding to favorites .....	<a href="#">50</a>
deleting a contact .....	<a href="#">48</a>
editing a contact .....	<a href="#">48</a>
filtering .....	<a href="#">51</a>
making a call using contacts .....	<a href="#">38</a>
searching .....	<a href="#">49</a>
contacts and call history	
synchronizing .....	<a href="#">50</a>
contact search	
IP Office .....	<a href="#">49</a>
content	
publishing PDF output .....	<a href="#">57</a>
searching .....	<a href="#">57</a>
sharing .....	<a href="#">57</a>
watching for updates .....	<a href="#">57</a>

## D

declining a call .....	<a href="#">40</a>
delete the call history .....	<a href="#">45</a>
deleting a contact .....	<a href="#">48</a>
device layout .....	<a href="#">23</a>
Avaya Vantage K155 .....	<a href="#">25</a>
K165 and K175 standard Avaya Vantage device .....	<a href="#">23</a>
disabling DND mode .....	<a href="#">54</a>
disabling video .....	<a href="#">53</a>
display	
changing wallpaper .....	<a href="#">54</a>
documentation portal .....	<a href="#">57</a>
finding content .....	<a href="#">57</a>
navigation .....	<a href="#">57</a>
document changes .....	<a href="#">8</a>
Do Not Disturb	
disabling .....	<a href="#">54</a>
enabling .....	<a href="#">54</a>
DTMF digits .....	<a href="#">41</a>

## E

editing a contact .....	<a href="#">48</a>
emergency call .....	<a href="#">37</a>
enabling	
Avaya Smart Lock .....	<a href="#">19</a>
enabling DND mode .....	<a href="#">54</a>

## F

favorite contacts .....	<a href="#">50</a>
features .....	<a href="#">11</a>
finding content on documentation portal .....	<a href="#">57</a>

**G**

Google Play applications ..... [14](#)

**H**

handset  
wireless ..... [21](#)

**I**

ignoring a call ..... [40](#)  
InSite Knowledge Base ..... [59](#)  
installing applications  
K165 and K175 ..... [15](#)  
installing third-party applications  
K155 ..... [16](#)  
IP Office contact search ..... [49](#)  
IP Office system contact ..... [49](#)

**L**

layout  
Avaya Vantage K155 ..... [25](#)  
K165 and K175 standard Avaya Vantage device ..... [23](#)  
legal notices .....  
locking ..... [17](#)  
locking when Smart Lock is enabled ..... [20](#)  
logging in ..... [16](#)  
logging out ..... [16](#)

**M**

making a call  
using call history ..... [39](#)  
using contacts list ..... [38](#)  
using dial pad ..... [38](#)  
using favorites list ..... [38](#)  
making a call using contacts ..... [38](#)  
making an emergency call ..... [37](#)  
making a second call ..... [39](#)  
merging calls into a conference ..... [46](#)  
muting a call ..... [41](#)  
My Docs ..... [57](#)

**N**

new in this release ..... [14](#)

**P**

physical layout ..... [23](#)  
placing a call on hold ..... [42](#)  
ports ..... [26](#)

**R**

redialing a number ..... [40](#)  
rejecting a call ..... [40](#)  
related documentation ..... [56](#)  
resuming a call ..... [42](#)  
ring tone  
changing default ring tone ..... [53](#)

**S**

saving  
system contact as a personal contact ..... [49](#)  
saving a system contact as a personal contact ..... [49](#)  
searching contacts ..... [49](#)  
searching for content ..... [57](#)  
second call ..... [39](#)  
selecting audio device ..... [43](#)  
setting contact display options ..... [50](#)  
sharing content ..... [57](#)  
support ..... [58](#)  
synchronizing contacts and call history ..... [50](#)

**T**

third party applications ..... [14](#)  
toggling calls ..... [42](#)  
trusted device  
changing ..... [20](#)  
removing ..... [20](#)  
turning on DND ..... [54](#)  
turn on the wireless handset ..... [22](#)

**U**

unlocking ..... [17](#)  
unmuting a call ..... [41](#)

**V**

video  
adding video to a call ..... [43](#)  
blocking and resuming ..... [43](#)  
disabling ..... [53](#)  
videos ..... [58](#)  
viewing call history ..... [44](#)

**W**

watch list ..... [57](#)  
wireless handset ..... [21](#)  
features ..... [12](#)  
layout ..... [30](#)  
LED indication ..... [13](#)  
turning on and off ..... [22](#)